



Other languages in digital format can be downloaded at [www.ostberg.com](http://www.ostberg.com)





The manufacturer cannot be held liable for injury and damage to people or property that are caused by incorrect installation, start up and/or incorrect use of the unit and/or failure to follow the processes and instructions that are set out in the user manual "Operation & maintenance". For safety reasons it is essential to follow the instructions in the user manual.

The warranty will be immediately invalidated in the event of injury that is caused by failure to follow the instructions. Installation and commissioning must be performed by a professional in order for the warranty to apply.

**Short cuts:**

**Log in Settings menu:** Enter code 1991. For Installation and Peripherals,

**Log in Service menu:** Enter code 1199. For end users

## Table of Content

<b>1</b>	<b>SAFETY</b> .....	<b>7</b>
1.1	Warnings .....	7
1.2	General safety .....	7
<b>2</b>	<b>WARRANTY</b> .....	<b>8</b>
2.1	Extent of the warranty .....	8
2.2	General limitations in the warranty .....	8
2.3	Limitations in the warranty .....	8
2.4	Service conditions during the warranty period .....	9
2.5	Corrective measures in the event of detected faults .....	9
<b>3</b>	<b>IQC</b> .....	<b>10</b>
3.1	IQC description .....	10
3.2	Control functions .....	10
3.2.1	Regulating the temperature .....	10
3.2.2	Fan capacity .....	11
3.3	Mount the antenna .....	11
<b>4</b>	<b>DISPLAYS AND PERIPHERALS</b> .....	<b>12</b>
4.1	Our displays IQC Display and IQC Easy .....	12
4.1.1	IQC Display .....	12
4.1.2	IQC Easy .....	13
4.2	Activate wired communication for IQC Display .....	13
4.2.1	Path in the IQC-panel – View A .....	13
4.2.2	Without Active dock holder – View B .....	13
4.2.3	Active dock holder with USB-charger – View C .....	14
4.2.4	Active dock holder – fixed connection – View D .....	15
4.2.5	Active dock holder – fixed connection RJ45 and contactless connection – View E-H .....	15
4.3	Instruction for paring of IQC-Displays .....	15
4.3.1	Main Display .....	16
4.3.2	Slave Display .....	16
<b>5</b>	<b>DISPLAY SYMBOLS AND FUNCTIONS</b> .....	<b>17</b>
5.1	Overview .....	17
5.2	The Display mode – Home screen simple and advanced .....	18
5.2.1	Status bar icons of the Home screen – both simple and advanced screen .....	18
5.2.2	Entering the basic settings for IQC Display .....	19
5.2.3	Use the main menu .....	19
5.2.4	Select preset home screen .....	19
5.3	Home screens .....	20
5.3.1	Icons .....	20
5.3.2	Home screen simple .....	20
5.3.3	Home screen advanced .....	21
5.4	Hotkey function .....	22
5.4.1	Temperature .....	22
5.4.2	Boost .....	22
5.4.3	Overpressure – is used to facilitate the lighting of a fireplace .....	22
5.4.4	Extended operation .....	23
5.4.5	Activate Away mode .....	24
5.5	Activate Screen Lock .....	24
5.6	Activate Night Cooling .....	24
5.7	Use the Alarm Menu .....	25
5.8	Scheduling .....	25
5.9	Turn the unit off and on .....	25
5.10	Change settings .....	26
5.11	Update firmware in the ventilation unit .....	26

Continues on the next page

<b>6</b>	<b>PERIPHERALS</b>	<b>27</b>
6.1	Heater and Cooler Outputs	27
6.1.1	Heater	27
6.1.2	Cooler	27
6.2	Dampers	27
6.3	Temperature sensors	28
6.4	Temp set point unit	28
6.5	I/O Modules	28
6.5.1	Expansions	28
6.5.2	Pressure transducer	29
6.5.3	Special settings (9900)	32
6.6	RH / CO2 / VOC sensor inputs	32
6.6.1	Digital Inputs	33
6.6.2	Digital Outputs	33
<b>7</b>	<b>REGULATION FUNCTIONS</b>	<b>34</b>
7.1	Startup procedure	34
7.2	Temperature Regulation	34
7.2.1	Supply air regulation	34
7.2.2	Room and Extract Regulation	34
7.2.3	Room and Extract Regulation with Summer/Winter changeover function	35
7.2.4	Supply Air Temperature Regulation Modes	35
7.2.5	Clean-up procedures (Exercise)	36
7.3	Scheduler	37
7.3.1	Scheduler – week	37
7.3.2	Holiday scheduler	37
7.4	Fan speeds	38
7.4.1	Away mode	38
7.4.2	Boost	38
7.4.3	Overpressure	39
7.4.4	Extended operation	40
7.4.5	Demand control via RH/CO2/VOC sensors	40
7.5	Alarms and limits	41
7.5.1	Alarm actions	42
7.5.2	Fire Alarm Auto Reset	44
7.6	Fan regulation	44
7.6.1	Percent (%)	44
7.6.2	CPC	44
7.6.3	CAV	45
7.6.4	VAV (Supply Air (SA) Slave)	45
7.6.5	VAV (Exhaust Air (EA) Slave)	45
7.6.6	Standard fan speed setup page	46
7.6.7	Min and Max speed setup pages	46
7.6.8	Flow direction	46
7.6.9	Flow display	47
7.7	Alarm relays	47
7.8	Night cooling (NC)	47
7.9	Temperature setpoint	48
7.10	Temperature setpoint max limit	48
7.11	Fallback management	49
7.12	Filter monitoring	49
7.12.1	Type of filter measurement mode that can be used	49
7.13	Load and save settings	50

Continues on the next page

<b>APPENDIX 1 IQC – INSTALLATON WIZARD</b>	<b>51</b>
<b>1.1 Step 1 – RH/CO2/VOC Boost</b>	<b>52</b>
<b>1.2 Step 2 – Heating and cooling</b>	<b>53</b>
<b>1.3 Step 3 – Temp regulation</b>	<b>55</b>
<b>1.4 Step 4 – Temp set point &amp; Supply temp low</b>	<b>58</b>
<b>1.5 Step 5 – Switches</b>	<b>59</b>
<b>1.6 Step 6 – Alarm class</b>	<b>61</b>
<b>1.7 Step 7 – Alarm output &amp; alarm relay</b>	<b>62</b>
<b>1.8 Step 8 – Filter measurement</b>	<b>63</b>
<b>1.9 Step 9 – Pressure range Duct</b>	<b>64</b>
<b>1.10 Step 10 – Dampers</b>	<b>65</b>
<b>1.11 Step 11 – Flow and regulation</b>	<b>66</b>
1.11.1 Regulation type "Percent (%)"	66
1.11.2 Regulation type "CPC"	67
1.11.3 Regulation type "CAV"	68
1.11.4 Regulation type "VAV (SA Slave)"	69
1.11.5 Regulation type "VAV (EA Slave)"	70
<b>1.12 Step 12 – Flow and regulation</b>	<b>71</b>
1.12.1 Regulation type "Percent (%)" – Min speed	71
1.12.2 Regulation type "CPC" – Min speed	71
1.12.3 Regulation type "CAV" – Min speed	71
1.12.4 Regulation type "VAV (SA Slave)" – Min speed	72
1.12.5 Regulation type "VAV (EA Slave)" – Min speed	72
<b>1.13 Step 13 – Flow and regulation</b>	<b>73</b>
1.13.1 Regulation type "Percent (%)" – Max speed	73
1.13.2 Regulation type "CPC" – Max speed	73
1.13.3 Regulation type "CAV" – Max speed	73
1.13.4 Regulation type "VAV (SA Slave)" – Max speed	74
1.13.5 Regulation type "VAV (EA Slave)" – Max speed	74
<b>1.14 Save settings</b>	<b>75</b>
<b>APPENDIX 2 IQC MENU STRUCTURE</b>	<b>76</b>
<b>2.1 Startup and main menu</b>	<b>76</b>
<b>2.2 Lock screen</b>	<b>76</b>
<b>2.3 Home screen</b>	<b>77</b>
2.3.1 Home screen simple	77
2.3.2 Home screen advanced	77
<b>2.4 Scheduler – "7.3 Scheduler" page 37</b>	<b>78</b>
<b>2.5 Alarms – "7.5 Alarms and limits" page 41</b>	<b>79</b>
<b>2.6 Settings</b>	<b>80</b>
<b>2.7 Service user special settings – code 9900</b>	<b>82</b>
<b>2.8 Service user – code 1199</b>	<b>83</b>
2.8.1 Service – setup	83
2.8.2 Service – Device pairing	87
<b>2.9 Service installation – code 1991</b>	<b>88</b>
2.9.1 Installation – Peripherals	89
2.9.2 Installation – Fan regulation	94
2.9.3 Installation – Temperature regulation	104
2.9.4 Installation – Filter monitoring	108
2.9.5 Installation – Alarm parameters	110
2.9.6 Installation – Alarm class	113
2.9.7 Installation – RH/CO2/VOC Boost	114
2.9.8 Installation – Communications	114
2.9.9 Installation – Alarm history	115
2.9.10 Installation – Operation info	116
2.9.11 Installation – Load & Save Settings	117
<b>2.10 Turn on/off unit</b>	<b>117</b>

# 1 Safety

## 1.1 Warnings

**WARNING!** A warning states a risk of personal injury.



**CAUTION!** A caution states a risk of damage to equipment.



## 1.2 General safety

**WARNING!** In accordance with IEC 60335-2-40, this apparatus is not intended to be used by people (including children) who have physical, sensory or psychological impairment, or lack of experience and knowledge, unless they have received guidance and instruction on how to use the apparatus by a person who is responsible for their safety. Children must be supervised to ensure that they do not play with the apparatus.



**WARNING!** Alle electrical installations must be performed by a qualified electrician.



**WARNING!** Alle changes or additions of electrical components must be performed by a qualified electrician.



**WARNING!** Ensure that the power cable is not damaged during mounting and installation.



**WARNING!** The unit may **not** be started until the installation is completely finished and the ducts have been connected.



**WARNING! Don't** use the safety Switch for normal starting and stopping of the unit. Use the IQC Display or the IQ Control App.



**WARNING!** The safety Switch must be switched off when the cover of the electrical distribution box or the doors/cover of the unit are opened/removed from the unit.



**CAUTION!** Always turn off the unit with the IQC Display or the IQ Control App before cutting the power.



**WARNING!** Alle operations on the unit and its peripheral equipment must be performed in accordance with local laws and regulations.



**WARNING!** Before servicing the unit, power must be disconnected for two minutes for the fans to stop.



**CAUTION!** The unit must not be turned off for longer periods unless the duct connections for outdoor air and extract air are re-plugged or dampers are installed due to the risk of condensation and freezing.



**CAUTION!** In the event of any interruption in power, the settings will be saved. Date and Time are saved for 24 hours. In longer interruptions, Date and Time must be reset.



## 2 Warranty

**The warranty's validity according to the purchase agreement is calculated from the day of purchase.**

### 2.1 Extent of the warranty

The warranty covers faults that occur during the warranty period that have been notified to the dealer or which have been verified by H.Östberg AB (underwriter) or the warranty provider's representative. Faults are defects in manufacture and materials as well secondary failures that occur due to these.

The above faults must be remedied so that the product is operational.

### 2.2 General limitations in the warranty

The warranty provider's liability is limited according to these warranty conditions and the warranty does not cover injury or damage to people or property. Verbal promises that are made in addition to the warranty agreement are not binding on the warranty provider.

### 2.3 Limitations in the warranty

The warranty applies on condition that the product is used in the normal manner or under equivalent circumstances and that the user instructions are followed.

**The warranty does not cover faults that are caused by:**

- Transport of the product.
- Unintended use or overloading of the product.
- Failure on the part of the user to follow the instructions regarding installation, use, maintenance and care.
- Incorrect installation or incorrect positioning of the product.
- Conditions that are not the responsibility of the warranty provider, e.g. excessive variations in voltage, lightning strike, fire and other accidents.
- Repairs, maintenance and changes that are performed by unauthorised parties.

**The warranty does not cover:**

- Faults that do not affect operation, for example scratches to the surfaces.
- Parts that are exposed to greater risk of fault than normal due to handling or normal wear and tear, for example lamps, glass, ceramics, paper or plastic parts, filters and fuses.
- Settings, information on use, care, service or cleaning that are typically described in the user instructions, or damage that is caused by the user failing to observe warnings or installation instructions, or inspection of such.

The warranty provider is only responsible for the operation if approved accessories are used. The warranty does not cover product faults that are caused by other manufacturers' accessories or equipment.

The unit's current settings must be recorded in the installation and assembly instructions at installation in order to avoid costs in the event of fault. The warranty provider is not responsible for costs such as adjustment costs when changing fans and controller in the unit.

## **2.4 Service conditions during the warranty period**

The conditions apply according to the agreement with the local dealer.

## **2.5 Corrective measures in the event of detected faults**

If a fault is detected, the customer must notify this to the dealer.

Shipping damage must be notified to the shipping agent upon delivery. State which product applies (part and serial number as per the name plate) and describe the fault and how this has occurred as accurately as possible.

In order for warranty repair to be performed, the customer must demonstrate that the warranty is valid by presenting a purchase receipt. Once the warranty period has expired, claims that were not made in writing before expiry of the warranty period will not be valid. In other regards, this shall occur in accordance with the sales conditions.

## 3 IQC

### 3.1 IQC description

Our intelligent control system for residential ventilation provides a healthy and energy-efficient indoor climate. Connect via internet, radio, Bluetooth or wire to your HERU air handling unit.

### 3.2 Control functions

#### 3.2.1 Regulating the temperature

The air temperature can be regulated for either constant supply, room or exhaust air temperature.

- To regulate room temperature, a sensor must be positioned in the room (accessory).
- The unit's inbuilt exhaust air sensor is used for exhaust air temperature.
- If the selected mode does not maintain the desired temperature, regulation moves to the next mode.

**There are 5 modes for regulating temperature:**

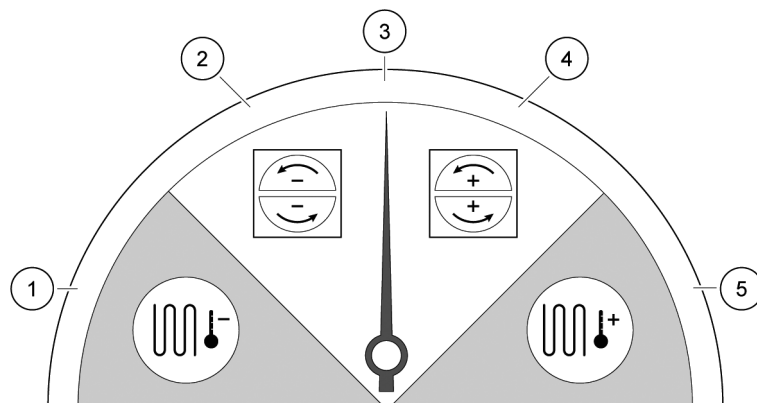

#### 1. Cooling recovery and/or after cooling

In climate conditions where the rotating heat exchanger is not adequate to achieve the desired supply air temperature, the unit can also control a cooling coil (accessory) (e.g. via geothermal heating) when the cooling recovery from the rotor is not sufficient to maintain the desired temperature.

#### 2. Cooling recovery

The rotating heat exchanger starts when cooling recovery is possible in order to maintain a lower supply air temperature.

#### 3. Outdoor temperature = desired temperature

When the outdoor temperature is the same as the desired supply air temperature, the rotating heat exchanger stops.

#### 4. Heat recovery

The rotating heat exchanger starts to recover the warm indoor temperature.

#### 5. Heat recovery and/or after heat

In climate conditions where the rotating heat exchanger is not adequate to achieve the desired supply air temperature, the unit can also control either the inbuilt electric after heater or a heating coil.

### 3.2.2 Fan capacity

Minimum airflow is set to suit the minimum requirement for ventilation. The standard setting is set to essential airflow for the ventilation. Maximum airflow is the airflow that is set to obtain higher airflow, if needed.

The airflow (the fan speed) can be controlled by a program scheduler, which can be programmed with specific times when the fan will switch from one speed to another.

Using the program scheduler, different fan speeds can be programmed, such as lowest, highest or standard fan speed. The fan speed can also be regulated by a carbon dioxide (CO<sub>2</sub>), volatile organic compound (VOC) and/or humidity (RH) sensor so that the unit increases the airflow as much as required in order to maintain the value once the value is exceeded.

“Night cooling” is a function that enables you to use the cold outdoor temperature at night to cool the indoor temperature. The fan speed is boosted when the difference between outdoor and exhaust air temperature lies within the programmed limits.

## 3.3 Mount the antenna

**CAUTION!** The antenna must not be left loose on or next to the unit.



**CAUTION!** The antenna must not be attached against any metal surface or object, as this will block the signal.



Attach the antenna in a suitable place not on the unit, should not be mounted on a metal surface. Place the antenna as centrally as possible in the building to maximize signal range in all directions.. An extension cord is available as an accessory, if required. **See web; Extension Cord – Antenna IQC**

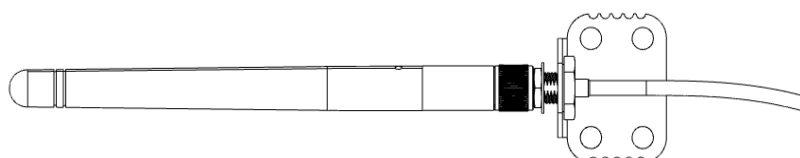

## 4 Displays and peripherals

### 4.1 Our displays IQC Display and IQC Easy

	IQC Easy	IQC Display	IQC Display + Active dock holder
100 m wireless range – clear line in sight		✓	✓
Push notifications within range		✓	✓
Basic control functionality	✓	✓	✓
Advanced control functionality		✓	✓
Wired communication	✓		✓
Offline mode (unit)	✓	✓	✓

#### 4.1.1 IQC Display

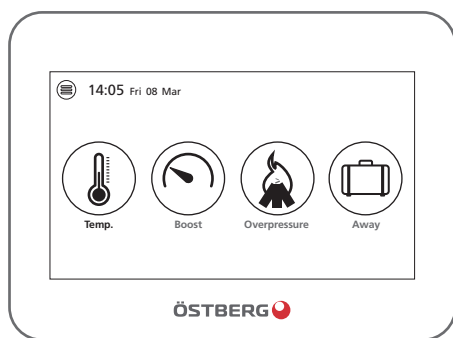

Advanced control panel for end users and installers.

#### Technical information

- Graphical User Interface – User friendly interface customized for the end user and the installer
  - Installation wizard that guides the installer through the installation.
  - Status bar for quick overview.
  - Quick info explaining the active panel [i] [?].
- Color Theme – Choose a light or dark color theme to match the interior design of your home.
- Screen saver / Lock screen – shows Time and Date and Temperature.
- Clock – Time and Date.
- Alarm history – Map the device's condition and facilitate service.
- Communication – Control your residential unit via radio and/or wired. A docking station is required for wired communication.

## 4.1.2 IQC Easy

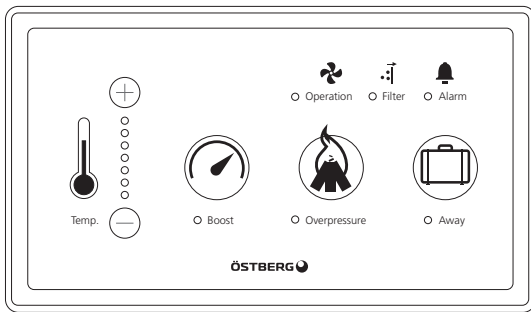

Wired control panel with basic end-user functions.

### Technical Information

The IQC Easy Controller is a new accessory that is used as a supplement for easier and more efficient control of your air handling unit.

- IQC Easy – used for settings of:
  - Desired temperature (18–24°C)
  - Boost
  - Overpressure
  - Away mode
- Displays active alarms (you need IQC App or IQC Display to reset alarms)

## 4.2 Activate wired communication for IQC Display

### 4.2.1 Path in the IQC-panel – View A

To find the setting for communication. Upper left corner "circle with three lines".  
 [Settings] > [General] > [Enable wired communication] > [ON/OFF].

### 4.2.2 Without Active dock holder – View B

The display is charged with the supplied USB-charger (1) and USB-micro/USB-A cable (2). The cable is connected between the display and the charger which is connected to a wall socket. The display can be used without the charger.

### Settings in the IQC-panel

No setting needs to be made, the display is automatically connected wireless.



View A – Settings.

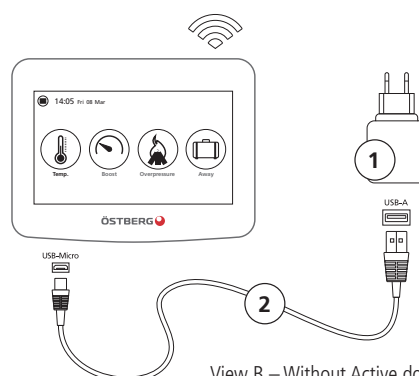

View B – Without Active dock holder – with USB-charger.

### 4.2.3 Active dock holder with USB-charger – View C

The display is charged through the Active dock holder (3). It's connected with the RJ45/USB-A cable (4), 4020657 which is a separate accessory, to the backside of the Active dock holder (3) (RJ45) and to the included USB-charger (1).

#### Settings in the IQC-Display

[Enable wired communication] = [OFF].



View C – Active dock holder – with USB-charger and RJ45/USB-A cable.

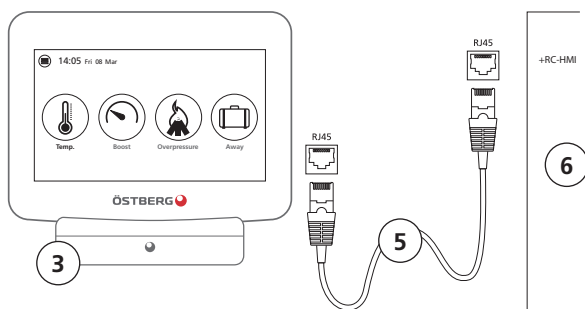

View D – Active dock holder – connected to the ventilation units with network cable.

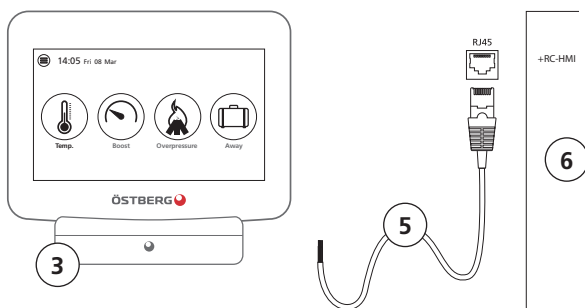

View E – Active dock holder – connected to the ventilation units with network cable with one end stripped.

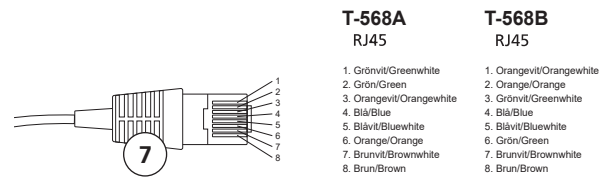

View F – Different standards on the plug, T-568A and T-568B.

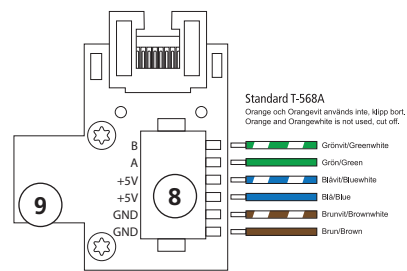

View G – Connection standard T-568A.

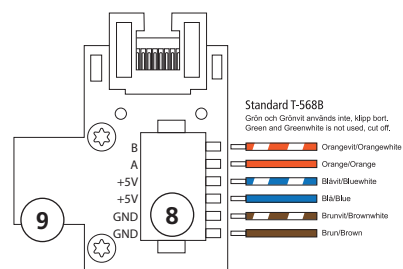

View H – Connection standard T-568B.

#### 4.2.4 Active dock holder – fixed connection – View D

The Active dock holder (3) is connected with a network cable RJ45/RJ45 (5) (not supplied) to the HERU unit, which takes care of both charging and communication to the unit (6). Connects to the unit's control board, connection marked "+ RC-HMI".

##### Settings in the IQC-Display

[Enable wired communication] = [ON].

#### 4.2.5 Active dock holder – fixed connection RJ45 and contactless connection – View E-H

The active holder (3) connects with a network cable with a stripped end (5) (not supplied) to the ventilation unit, which takes care of both charging and communication to the unit (6). Connects to the unit's control board, connection marked "+ RC-HMI".

Connect the cable according to view G and H. Be aware on which type of cable you use, they are connected differently in the plug (7). The two different standards are T-568A and T-568B. The most common is T-568B. Push in the stripped cable ends in the connector (8) on the connector board (9) on the active dock holder (3).

##### Settings in the IQC-Display

[Enable wired communication] = [ON].

### 4.3 Instruction for paring of IQC-Displays

The first IQC-Display can be wired or wirelessly connected to the unit and is also the main display with [Display ID 1]. If an additional IQC-Display is desired, it must be paired as a slave display with [Display ID 2]. Only one display can be wired to the unit, if two IQC-Displays is used one of them must be wireless connected.

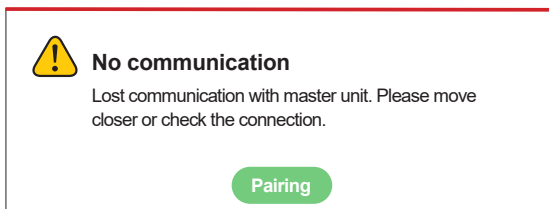

15 View A

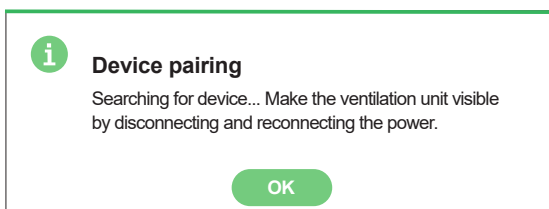

View C

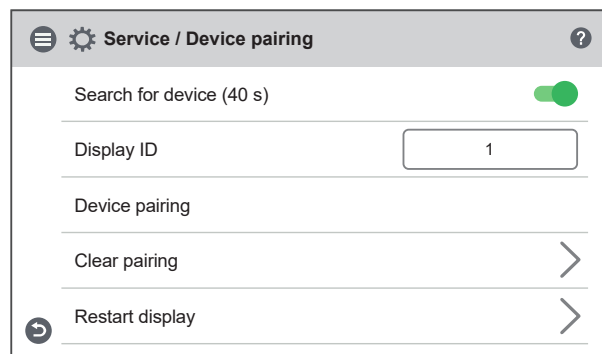

View B

### 4.3.1 Main Display

1. Connect the IQC Display Active holder to the HMI port in the unit or power the display via a wall outlet. The display shows **[No communication]**. View A.

#### **Step 2 to step 8 is not necessary at the first pairing attempt**

2. Open the main menu, select **[Service]**.
3. Log in. Enter code **[1199]**.
4. Select **[Unit pairing]**.
5. To add a display as master, enter **[Display ID 1]** and press OK.
6. Open the main menu, select **[Service]**.
7. Log in. Enter code **[1199]**.
8. Select unit pairing.
9. Press **[Pairing]**. View A.
10. Activate the toggle **[Search for Device (40s.)]**, View B. The wireless IQC-display will then be in search mode for 40 seconds. Make the unit visible for pairing by turning power to the unit off and on View C.
11. If the IQC Display can't be found, the following is shown in the display **[Pairing units failed. No unit found]** in the display. The wireless display returns to the menu **[Device pairing]**. Repeat step 10.
12. If the unit is found, the following is displayed **[Unit found. Pairing key:]** (unique number).
13. Press **[OK]** to confirm.
14. The wireless display now starts to synchronise data from the unit.
15. Pairing of the IQC Display is complete.

### 4.3.2 Slave Display

1. Connect the IQC Display Active holder to the HMI port in the unit or power the display via a wall outlet. The display shows **[No communication]**. View A.
2. Press **[Pairing]**. View A.
3. To add a display as slave, enter **[Display ID 2]** and press OK..
4. Activate the toggle **[Search for Device (40s.)]**, View B. The wireless IQC-display will then be in search mode for 40 seconds. Make the unit visible for pairing by turning power to the unit off and on.
5. If the IQC Display can't be found, the following is shown in the display **[Pairing units failed. No unit found]** in the display. The wireless display returns to the menu **[Device pairing]**. Repeat step 4.
6. If the unit is found, the following is displayed **[Unit found. Pairing key:]** (unique number).
7. Press **[OK]** to confirm.
8. The wireless display now starts to synchronise data from the unit.
9. Pairing of the IQC Display is complete.

## 5 Display symbols and functions

For information on active view in the IQC-Display or the IQ Control App, press the i-button [i] [?] in the displays status bar.

**WARNING!** The unit's duct connections must be duct connected, and doors/cover closed and locked before the unit is started in order to avoid the risk of personal injury from rotating parts.



**CAUTION!** The unit must be run constantly and only be stopped for maintenance.



**CAUTION!** The safety switch must not be used for normal starting and stopping of the unit. Use the IQC-Display or the IQ Control App.



**CAUTION!** In the event of interruption in power, the settings will be stored. Date and Time are saved for 24 hours. After that, Date and Time must be reset. Make sure the unit is started up.



### 5.1 Overview

The airflow is regulated by the different modes, set in the IQC-Display or the IQ Control App. Standard mode is default.

#### Accessible modes

<b>Standard</b>	Adjusted at installation, must not be changed.
<b>Boost</b>	A higher airflow than standard (Max fan speed). This alternative should be used when there is need for a higher airflow, for example when cooking food or drying laundry
<b>Overpressure</b>	Pressure compensation in the event of supplementary heating, for example, when using an open cooker or stove.
<b>Extended Operation</b>	Possibility to control the unit to extended operation according for a specific time in addition to regular operating scheme.
<b>Away</b>	Reduced air flow, can be used when no one is home.

Certain settings are protected by a code so they cannot be changed unintentionally.

**NOTE!** If a mode is activated manually, the programmed or previous settings are overruled due to priorities.



## 5.2 The Display mode – Home screen simple and advanced

There are two home screens – **Home screen simple** and **Home screen advanced**. For information on active view in the wireless display, press the [i-button] in the displays status bar.

### 5.2.1 Status bar icons of the Home screen – both simple and advanced screen

Figure between paragraphs is how many different stages there are of each place holder in the status bar. The empty frame marks there is no icon showing in the status bar. The following variable symbols can be displayed in the status bar:

The diagram shows a status bar with the following elements from left to right: a menu icon (1), time '12:34' (2), date 'Mån 06 Juni' (2), an information icon (3), a connection status icon (4), 'CO2' (5), a radio/cable icon (6), a battery level icon (7), a night cooling icon (8), a heater/cooler icon (9), an away mode icon (10), a program icon 'W5' (11), an alarm icon (12), and 'Larm(XX)' (13).

<p><b>1. Main menu</b></p> <p><b>2. Date and time</b></p> <p><b>3. Information about the active view</b></p> <p><b>4. Status cloud connection (3)</b></p> <ul style="list-style-type: none"> <li><input type="checkbox"/> Not activated</li> <li><input checked="" type="checkbox"/> Connection off</li> <li><input checked="" type="checkbox"/> Connection on</li> </ul> <p><b>5. Air quality compensation for high level of a sensor (4)</b></p> <ul style="list-style-type: none"> <li><input type="checkbox"/> The limit value has not been reached</li> <li><b>CO2</b> Demand-controlled flow increase to set limit value (air quality).</li> <li><b>VOC</b> Demand-controlled flow increase to set limit value (air quality).</li> <li><b>RH</b> Demand-controlled flow increase to set limit value (air quality).</li> </ul> <p><b>6. Radio or cable connected communication (5)</b></p> <ul style="list-style-type: none"> <li>Radio connected</li> <li>'P' 'P' ('P') (('P'))</li> <li>Cable connected (connected to dock)</li> <li></li> </ul> <p><b>7. Battery level flashing when charging (5)</b></p> <ul style="list-style-type: none"> <li></li> </ul>	<p><b>8. Night cooling active (2)</b></p> <ul style="list-style-type: none"> <li><input type="checkbox"/> Not active</li> <li><input checked="" type="checkbox"/> Night cooling active</li> </ul> <p><b>9. Heater/Cooler active (3)</b></p> <ul style="list-style-type: none"> <li><input type="checkbox"/> Non active</li> <li><input checked="" type="checkbox"/> Heating active</li> <li><input checked="" type="checkbox"/> Cooling active</li> </ul> <p><b>10. Away mode (2)</b></p> <ul style="list-style-type: none"> <li><input type="checkbox"/> Not active</li> <li><input checked="" type="checkbox"/> Active</li> </ul> <p><b>11. Active program, program no. 5 (3)</b></p> <ul style="list-style-type: none"> <li><input type="checkbox"/> No program</li> <li><b>W5</b> Week program</li> <li><b>H5</b> Holiday program</li> </ul> <p><b>12. Alarm active (4)</b></p> <ul style="list-style-type: none"> <li><input type="checkbox"/> No Alarm</li> <li><input checked="" type="checkbox"/> Visible temporary at upstart</li> <li><input checked="" type="checkbox"/> B-Alarm</li> <li><input checked="" type="checkbox"/> A-Alarm</li> </ul> <p><b>13. Only active if there is a alarm in nr. 12</b></p>
--	---

### 5.2.2 Entering the basic settings for IQC Display

1. Open the main menu, select **[Settings]**.
2. Select **[General]**.
3. Select **[Language]** from the list.
4. Enter **[Time]**.
5. Select **[Measurement system]** from the list.
6. Select **[Time format]** from the list.
7. Select **[Time zone]** from the list.

### 5.2.3 Use the main menu

1. Open the main menu: Press on the **[Main menu]** button in the upper left corner. Scroll through the menus using your finger.
2. Close the main menu to return to the home screen: Press button **[X]** in the upper left corner.

### 5.2.4 Select preset home screen

The preset choice is **[Home screen]** simple.

To select **[Home screen advanced]**, perform the following steps:

1. Open the main menu, select **[Settings]**.
2. Select **[General]**.
3. Scroll right down the menu and activate the icon for **[Home screen advanced]**.  
Return to the main menu. Press on the **[Main menu]** button in the upper left corner.  
Return to the home screen. Press button **[X]** in the upper left corner.

## 5.3 Home screens

### 5.3.1 Icons

- **Temperature** – shows three different temperature sensors value
- **Boost** – Meter pointer is animated, colored ring shows that function is active.
- **Overpressure** – flame is animated when active, colored ring shows that function is active. Ext. operation and overpressure share the same position.
- **Extended operation** – has the possibility to show either if an external switch is activated or the timer, colored ring shows that function is active. Toogle Ext. operation to off under **[Settings] > [General]** to show Hotkey for overpressure on home screen.
- **Away** – has the possibility to show either if an external switch is activated or the timer.
- **Fans** – the symbol rotates when fans are active. Under the symbol there are two different informations depending on which one are chosen, flow or pressure.
- **Sensor** symbol shows which different types of sensors that are connected.
- **Rotor** – the symbol can be grey, blue or red – it also rotate when the rotor turning. Color depends on if the unit is recovering cold (blue symbol) or warm (red symbol) air. It also shows the efficiency in %.
- **Filter** – has three different possibility, timer, flow or pressure mode.

### 5.3.2 Home screen simple

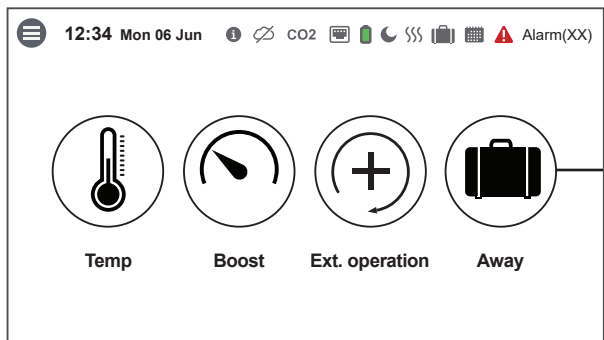

Status bar, all symbols have a explaining text. Just press the symbol

Hotkeys to activate or deactivate functions for the modes: **Boost, OverPressure / Extended Operation** and **Away mode**, Boost are also animated. For access to all Hotkeys, just press the screen.

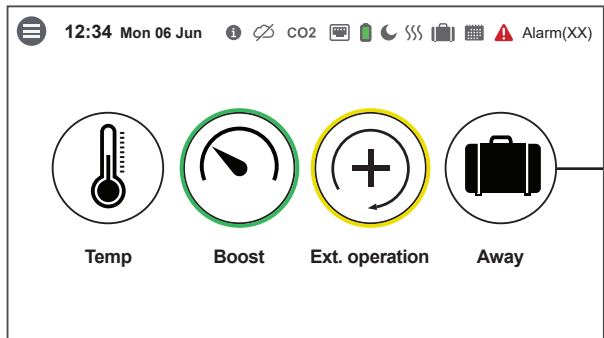
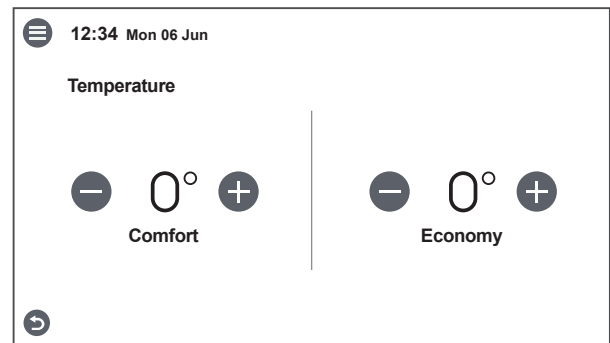
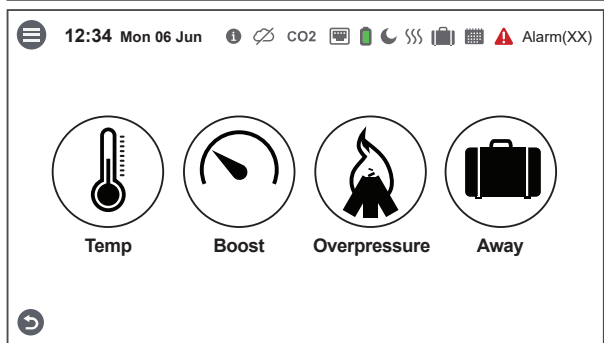

If a Hotkey is active there is a colored ring around the symbol. Green if it's active, yellow if it active but an another Hotkey has priority.

In this example, Boost is active and Ext. Operation is inactive but inactivated by Boost. Boost has the highest priority.

### 5.3.3 Home screen advanced

**Home screen advanced** shows the same status and hotkeys as Home screen simple. Home screen advanced shows more information on hotkey status, not just on/off. An extra page of information on operation of the HERU units is also available. Ext. operation and overpressure share the same position.

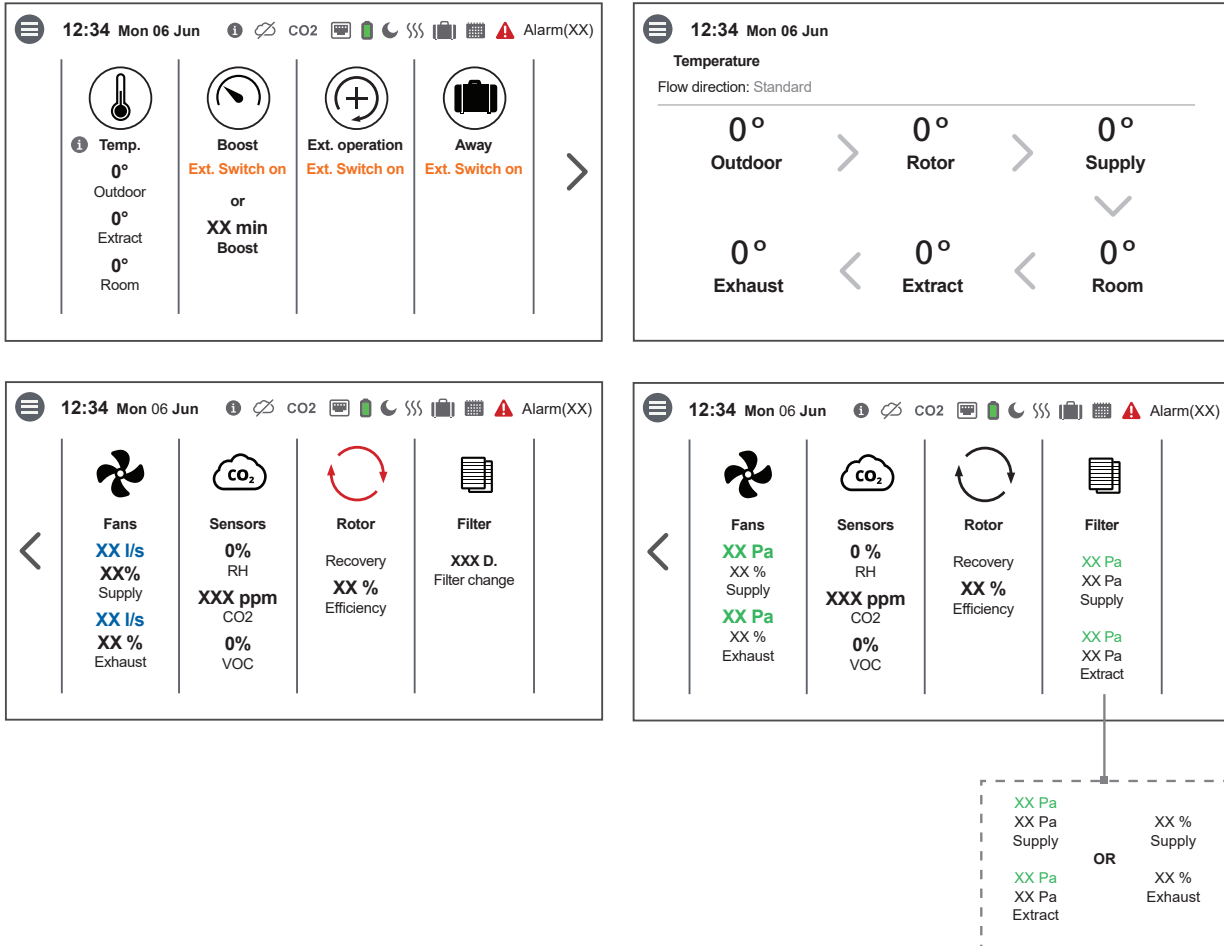

If a Hotkey is active there is a colored ring around the symbol. Green if it's active, yellow if it activated but inactive – an another Hotkey has priority, see Home screen simple for color example. Boost, Fans, and Rotor are animated.

In this example, Boost is active and Ext. Operation is inactive but inactivated by Boost. Boost has the highest priority. If there is an external switch activated it can be shown under Boost, Ext. Operation and Away.

The active sensor flashes until the set value is reached on the home screen advanced.

## 5.4 Hotkey function

### 5.4.1 Temperature

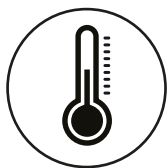

1. Press on the icon for temperature.
2. Set desired temperature. Use the buttons [-] and [+].
3. Return to the home screen. Press on the arrow in the bottom left corner or on the main menu button in the upper left corner.

### 5.4.2 Boost



#### Boosting the unit

1. Press on the icon [Boost]. Operation in boost mode is shown with a green circle around the icon. Deactivate by clicking on the icon again.

#### Change operating time for boost



**NOTE!** The preset time for boost operation is 30 minutes. Longer boost-time may lead to higher energy consumption.

1. Open the main menu, select [Service].
2. Log in. Enter code [1199].
3. Select [Setup].
4. Scroll down to [Boost] and change the operating time.
5. Return to the main menu. Press on the [Main menu button] in the upper left corner.
6. Return to the home screen. Press button [X] in the upper left corner.

For extended information, see "7.4.2 Boost" page 38

### 5.4.3 Overpressure – is used to facilitate the lighting of a fireplace



## Activate Overpressure

1. Press on the icon **[Overpressure]**. Operation in Overpressure mode is stated with a green circle around the icon. Deactivate by clicking on the icon again.

## Change operating time and compensation for Overpressure function

**NOTE!** The preset time for Overpressure is 15 minutes. Longer overpressure-time may cause ingress of humidity in the building structure.



1. Open the main menu, select **[Service]**.
2. Log in. Enter code **[1199]**.
3. Select **[Setup]**.
4. Scroll down to **Overpressure** and change the operating time.
5. State desired **[Offset]** value (25%).  
Offset is the difference between supply and exhaust air. The supply air fan is increased first. If the supply air fan reaches the limit for maximum fan speed, the exhaust air fan is reduced until the difference between the fans corresponds to the offset value.
6. Return to the main menu. Press on the **[Main menu button]** in the upper left corner.
7. Return to the home screen. Press button **[X]** in the upper left corner.

For extended information, see **"7.4.3 Overpressure" page 39**

### 5.4.4 Extended operation

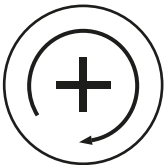

## Activate Extended operation

1. Press on the icon **Extended operation**. Operation in Extended operation mode is stated with a green circle around the icon. Deactivate by clicking on the icon again.

## Change operating time and compensation for Extended operation function

**NOTE!** The preset time for Extended operation is 240 minutes.



1. Open the main menu, select **[Service]**.
2. Log in. Enter code **[1199]**.
3. Select **[Setup]**.
4. Scroll down to **[Extended operation]** and change the operating time.
5. Return to the main menu. Press on the **[Main menu button]** in the upper left corner.
6. Return to the home screen. Press button **[X]** in the upper left corner.

For extended information, see **"7.4.4 Extended operation" page 40**

### 5.4.5 Activate Away mode



**NOTE!** The away mode is prioritised and overrides the program planner if both are active simultaneously.

1. Press on the icon **[Away]**. Operation in away mode is stated with a green circle around the icon. The away mode is active until it is manually deactivated by pressing on the icon again.

**For extended information, see “7.4.1 Away mode” page 38**

## 5.5 Activate Screen Lock

The screen can be locked in order to avoid unintentional changes.

1. Open the main menu, select **[Lock screen]**. The screen locks and a padlock is displayed.
2. To unlock the screen, press on the screen and hold for three seconds.

## 5.6 Activate Night Cooling

Night cooling is a temperature regulated boost without heat recovery, where the unit is cooled with cold outdoor air as needed. Night cooling is activated when the exhaust air temperature is higher than **[Exhaust air high]** and outdoor temperature is colder than **[In/Out diff]**. Night cooling is deactivated when the exhaust air temperature is lower than **[Exhaust air low]** or the outdoor temperature is warmer than **[In/Out diff]**.

Standby Temp. Evaluation must be activated if the unit is in standby mode and Night cooling is desired. Standby Temp. Evaluation runs the unit by the set time intervals to update temperatures to check, whether the temperature criteria for activating night cooling has been fulfilled.

1. Open the main menu, select **[Service]**.
2. Log in. Enter code **[1199]**.
3. Press **[OK]**.
4. Select **[Setup]**.
5. Scroll down to **[Night cooling]**. Press the **[Activate toggle]**.
6. Enter the selected value.
7. If the unit is in standby and night cooling is desired, activate **[Temp. Evaluation]**.
8. Enter the selected value.
9. Return to the main menu. Press on the **[Main menu]** button in the upper left corner.
10. Return to the home screen. Press button **[X]** in the upper left corner.

## 5.7 Use the Alarm Menu

1. Open the main menu, select **[Alarms]**.
2. Select **[Active alarms]** to see all active alarms.
3. After managing an active alarm, the active message for the alarm is cleared.
  - Click on the alarm to reset it. In the dialogue box displayed, select **[Reset]**.
  - In order to reset all active alarms, click on **[Reset all]** in the upper right corner in **[Active alarms]**.
4. Select **[Alarm history]** to see all previous alarms.
5. Return to the main menu. Press on the **[Main menu button]** in the upper left corner.
6. Return to the home screen. Press button **[X]** in the upper left corner.

## 5.8 Scheduling

### There are two types of schedules

**Scheduler** for programming the intervals for weekdays and **Holiday scheduler** for programming per date. **Holiday scheduler** overrides **Scheduler** for weekdays. If the different schedules coincide with each other, the schedule with the lowest number overrides the other.

The Scheduler can be used in both **comfort** and **economy mode**, if the economy temperature is activated.

1. Open the main menu, select **[Scheduler]**.
2. Select type of schedule.  
The upper icon automatically toggles on when one or more program is activated. When you deactivate this toggle, all programs are deactivated.
3. Select **[Program 1]** by clicking on it.
4. Enter the selected value.
5. Select **[Fan speed]**. Select **[Min]**, **[Std]**, **[Max]** or **[Standby]** from the drop down list.
6. If economy temperature is activated, select **[Temp. Mode]**. Select **[Comfort]** or **[Economy]** from the drop down list.
7. Click on the button **[Save]**. The program has been activated. Press the toggle to deactivate the program.
8. To set several different programs, repeat steps 1 – 7 as required.
9. Return to the main menu. Press on the main **[Menu button]** in the upper left corner.
10. Return to the home screen. Press button **[X]** in the upper left corner.

## 5.9 Turn the unit off and on

1. Starting the unit. Connect plug/turn on the safety switch.
2. Press on the display and click on **[OK]** to the question **[Start unit]?**.
3. Turning off the unit. Open the main menu, scroll down and select **[Turn off the unit]**.

## 5.10 Change settings

For all available options, see **“Appendix 2 IQC Menu structure” page 76**

1. Open the main menu, select the desired alternative to be changed.
2. Change the parameters to the desired value.
3. Return to the main menu. Click on the **[Main menu button]** in the upper left corner.
4. Return to the home screen. Press button **[X]** in the upper left corner.

## 5.11 Update firmware in the ventilation unit

### Preparations:

Download the latest version of the software. The update file has the extension .m3f.

- Save the m3f file in a suitable location on the computer’s hard drive, for example on the desktop.
- Right-click the file on the desktop that has the extension .m3f and select copy.

### Update procedure

1. Make sure the unit has power. The unit does not have to be switched on.
2. Connect the IQC-Display unit to the computer with a Micro USB type USB cable for data transfer.
3. The IQC-Display unit appears as a storage device in the computer. You may need to select what action to take when the IQC-Display unit is found. Select the option that opens the device in the file manager. The IQC-Display should show “Installation Menu” when connected correctly.
4. In file manager, right-click on the IQC-Display storage device and select paste the file with the extension .m3f (previously copied).
5. The IQC-Display starts the update immediately. First, the IQC-Display is updated. The update process can be seen in the IQC-Display (0-100%). A short verification (0-100%) is then performed before the IQC-Display restarts.
6. After the IQC-Display has restarted, it can be disconnected from the computer.
7. Ensure that the IQC-Display get connection to the unit via the docking station or wireless connection. The IQC-Display synchronizes with the unit and evaluates the existing version in the main board. If two IQC-Displays are used, see also point 10.
8. If the main board in the unit has a lower version than the updated IQC-Display, the IQC-Display will also start updating the main board. The update process for “main board update” is shown in the IQC-Display (0-100%). Then the unit will start up for normal operation.
9. In some cases, when using wireless connection, the IQC-Display may need to be paired again after an update. If so, continue in the section Device Pairing.
10. If two IQC-Displays are used and are paired with the unit, the main board is only updated from the master IQC-Display. (ID number 1, see under Menu/Service (1199)/Device pairing). If two IQC-Displays are used, then repeat steps 2-6 for the second IQC-Display.
11. Verify that the downloaded version has been correctly installed on both the IQC-Display and the main board by going to Menu/Settings/About.
12. Update of IQC-Display and unit is now ready.

## 6 Peripherals

### 6.1 Heater and Cooler Outputs

#### 6.1.1 Heater

There are four possible selections for after heater: None, Water, Electric and PAC-IF013.

1. If none is selected, no after heater will be applied, and the heating mode will not be used.
2. If after heater, water, is selected, the relay board controls the valves and pump for the water heater. The water heater option will require a freeze protection sensor installed on the return water pipe to monitor the return water temperature. When the unit is in standby mode the water heating coil is kept at a holding temperature setpoint to prevent freeze damage to the coil. Either if the unit is in operation or in standby mode, the return water temperature is constant monitored and compared against the freeze protection limit setpoints to prevent and even stop the unit if necessary, to prevent freeze damage to the coil.
3. If electric heater is selected, a pulser will control the heater and if no Load is connected to the pulser e.g. the thermal protection is tripped (or the heater is not connected to main supply), an alarm is raised.

The electric heater, aftercooling function can be used (recommended) to cool off the heater after it has been active. Aftercooling function will keep the supply fan running for 2 minutes. It will also apply if the unit is manually turned off or by a scheduled standby.

4. The option PAC-IF013 is available to select when a expansion board is present and activated in the installation menu. It's used for controlling a specific heat pump Modell along with a combi coil for both heat and cooling possibility.

#### 6.1.2 Cooler

There are three possible selections for cooling: None, Water, and PAC-IF013.

1. If none is selected, no cooler will be applied and cooling mode will not be used.
2. If water cooler is selected, the relay board controls the valves and pump for the water cooler.
3. The option PAC-IF013 is available to select when a expansion board is present and activated in the installation menu. It's used for control a specific heat pump Modell along with a combi coil for both heat and cooling possibility.

### 6.2 Dampers

Dampers (if installed) is prioritized to be opened before the fans are allowed to start. Opening time can be set under the Installation / Peripherals menu to meet requirements for used dampers.

#### The valve is closed if

1. Fire alarm modes (see fire alarm).
2. The unit is turned off.
3. System is in scheduled stand-by, and the fans are stopped.

Some functions may cause the dampers to be open e.g. standby temp. evaluation and extended operation.

## 6.3 Temperature sensors

The controller support both the PTC and KTY temperature sensors. The controller supports sensor adjustment ability for each sensor individually. Range from  $-5.0^{\circ}\text{K}$  to  $+5.0^{\circ}\text{K}$  with 0.1 steps.

For units that can be changed to be either right-hand or left-hand versions, the controller will automatically reassign the function of the internal temperature sensors according to selected flow direction.

The function of each sensor in standard and Motsatt flow direction is listed below:

Temperature sensor	Sensor connection	
	Standard flow	Motsatt flow
Fresh air temperature	T1	T3
Rotor temperature	T2	T4
Extract air temperature	T3	T1
Exhaust air temperature	T4	T2
Freeze protection sensor	T5	T5
Supply duct temperature	T6	T6
Room air temperature	T7	T7

## 6.4 Temp set point unit

### Temp Setpoint Adjustment

For units with full-scale expansion there is possibility to offset the comfort temperature setpoint between  $\pm 1\text{K}$  and  $\pm 5\text{K}$  via external 0-10V input. The selected temperature range is scaled to the 0-10V input with a starting point where  $5\text{V}=0\text{K}$ .

The compensation factor will never be able to affect the comfort temperature setpoint lower than  $15^{\circ}\text{C}$ . If the input gives a compensation factor of  $-5\text{K}$  and the temp. setpoint is set to  $19^{\circ}$ , compensation will be the difference down to  $15^{\circ}$ , i.e.  $-4\text{K}$ . The same applies upwards towards the maximum setpoint limit. The compensation value is visible under the temperature page when function is active and other than  $0\text{K}$ .

## 6.5 I/O Modules

### 6.5.1 Expansions

Full-scale expansion board or mini expansion board can be activated under the I/O modules menu.

When an expansion board is selected, the controller will try to detect if the expansion board is connected and if no expansion board can be found, a message box will be given saying "Expansion board not found".

If expansion board is found, the message box will be given saying "Expansion board activated" and the selected expansion board will be selected in the dropdown list and the menu choices related to selected expansion board will be available in display.

If the expansion type is set to none, this will be followed up with the warning box "Are you sure?". If ja, the expansion board will be disabled, Menus and menu options related to the expansion boards will be unavailable.

Only the control functions that depend on the expansion board will be visible and can be managed.

Values/settings for fan regulation, cooling, filter measurement, change over, setpoint adjustment, / Pressure sensors and flow sensors are saved (separately) to be recalled when/if the expansion board is activated again.

When deactivating the expansion board, the program will set fan regulation type to Static fan regulation (%), cooling to none, filter monitoring to filter timer, changeover input to temp. and setpoint adjustment to off.

Upon start up a check for expansions are made. If an expansion board is connected, but not activated, a message box will prompt "Expansion board found, activate?"

If no is selected, the expansion type setting will remain in state none. No menu change in function. Manual activation is needed.

If ja is selected, a message box will prompt "Expansion board enabled" and the expansion type setting will be set and the menu choices related to selected expansion board will be available in the IQC-Display or IQ Control App.

If an expansion board is activated and a communication error occur, an alarm will be given and then fallback handling will be initiated. This applies regardless of startup or normal operation. Alarm and fallback handling are initiated after 30s of failed communication.

### **6.5.2 Pressure transducer**

The unit's fans and air flows can be regulated to maintain pressure in the duct and/or via flow, and the supply/exhaust air filter can be monitored. For this to work, Pressure sensors must be installed and configured correctly.

Values from the Pressure sensors can be retrieved either via 0-10V or via Modbus, depending on peripherals and configurations made for the duct-, flow- and filter sensor. The Pressure sensor unit supported by the controller, has two Pressure sensors per unit, presented as P1 and P2 on the unit.

Modbus peripherals are managed via the I/O bus when no expansion board is connected, and the controller communicates directly with e.g. Pressure sensor (via Modbus RTU). If a full-scale expansion board is connected, the I/O-bus runs with the internal protocol for fast communication between the internal expansion modules and communication with modbus peripherals will instead take place via the AIP-bus (Modbus RTU). The Expansion board is equipped with two AIP-bus channels.

In the event of lost communication to the Pressure sensors that are controlled via modbus, the control will initiate a fallback handling.

The available choices in the dropdown lists are depending on conditions such as if an expansion board is connected and activated or which type of input that is selected to be used.

Which type of signal that's possible to use and where the Pressure sensors are connected, is listed in table below:

Pressure sensors	Signal type	
		Analog 10V
Via Main	-	I/O-bus
Via Expansion	0-10V	AIP-bus

Pressure sensors for filter monitoring and flow measurement must be assigned the correct function depending on if they are external or integrated into the unit.

For Pressure sensors that are external connected to units that is equipped with Pressure outlets, their function will be individual, which means that one sensor unit has a specific task, for example measuring both filters.

For Pressure sensors that are integrated into the unit, their function will be combined, which means that one sensor unit has two tasks, measuring one filter and one fan.

**Note:** The Duct Pressure sensor will always be assigned function as individual.

**Via Main: I/O-bus**

- The Sensors are individual and have a task per unit such as Duct-, Flow- or Filter measurement.
- Flow- or Filter sensors

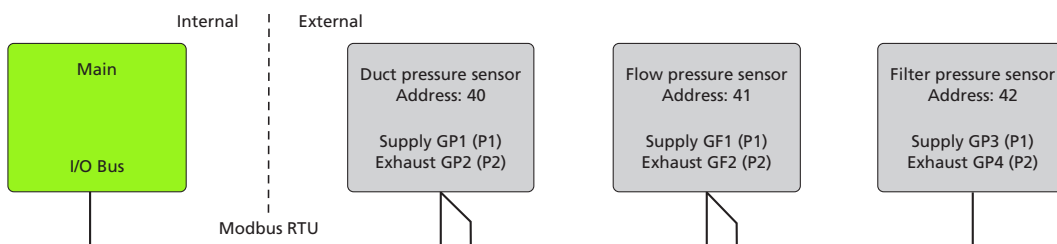

**Via Expansion: 0-10V**

The function of the Pressure units can be set either as Individual or as Combined.

- Individual
  - Set as Individual, a task is given per unit such as Duct, Flow or Filter. No flow direction dependence in the program as the external installation of Ppressure hoses is given.

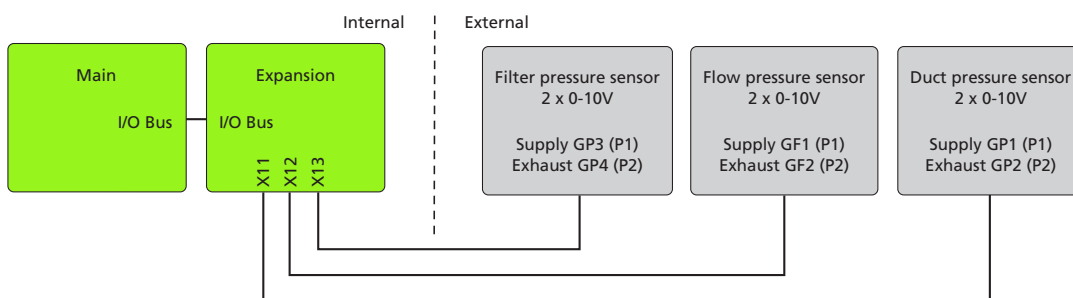

- Combined
  - Set as Combined, two internal Pressure units are given the combined function Flow + Filter. One unit on each side. The Pressure units that are placed internally are therefore flow direction dependent and their task/function changes with the choice of flow direction.

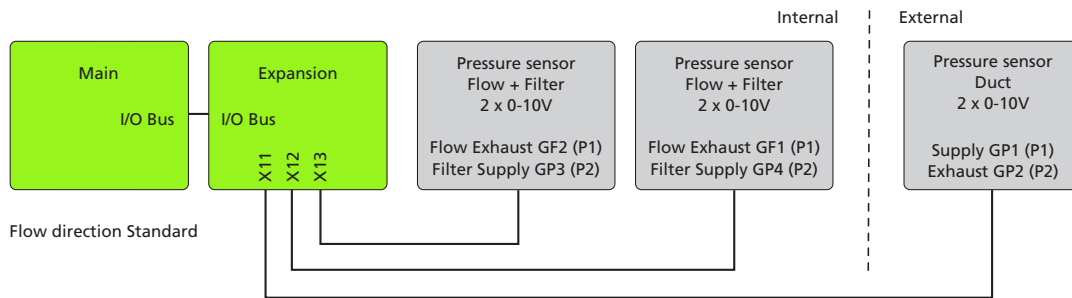

### Via Expansion: AIP-bus

- AIP bus is divided into two channels, one channel per side of the ventilation unit.
- The Pressure units that are placed internally are flow direction dependent and their task/function changes with the choice of flow direction.

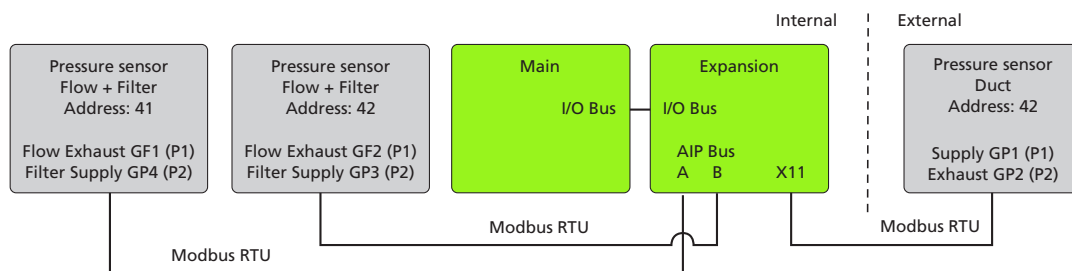

### Pressure range

When using Pressure transducer with 0-10V output signal, the correct Pressure range must be selected in the program so it corresponds to the setting made in the Pressure transducer so the 0-10V signal can be mapped correctly.

Pressure ranges that are supported:

1. 0-100 Pa
2. 0-250 Pa
3. 0-300 Pa
4. 0-500 Pa
5. 0-700 Pa
6. 0-1000 Pa
7. 0-1250 Pa
8. 0-1500 Pa
9. 0-2000 Pa
10. 0-2500 Pa

### **K-factor**

The unique flow coefficient for the fan mounted in the unit can be set under the peripheral menu for the flow sensor.

Actual flow value from fans is calculated with the formula  $Q=k*\sqrt{\Delta Pa}$  where  $\Delta Pa$  is the Pressure measured by the sensor and k is the k-factor given for the fan. The k-factor is by factory preset.

### **Zero-point calibration of Pressure sensors**

For Pressure sensor that is connected via 0-10V, a zero-point calibration must be initiated from the Pressure sensor by holding the push button for more 10s.

For Pressure sensor that is connected via modbus, a zero-point calibration can be initiated from the display.

When starting zero-point calibration from the display, you first get a red information box 'Warning' which announces what needs to be done before calibration is performed.

- The 'Cancel' option cancels the operation and returns to the previous menu without starting the zero-point calibration.
- Pressing 'Start' will initialize the zero-point calibration.
- During the procedure, a yellow information box 'Calibrates...' is displayed and the Pressure sensor unit is calibrating and will return to normal operation when done.
- Then the green information box 'Done' confirms that the zero calibration is completed.

### **Note**

Disconnect the Pressure hoses connected to the Pressure sensor before performing a zero calibration.

Reconnect the Pressure hoses to the sensor when the Zero-point calibration is completed.

## **6.6 Special settings (9900)**

When installing a new control board, for example when a previous control board must be replaced, unit-specific settings need to be made. When a new control board is started, a check box will automatically appear in the display notifying that important settings needs to be made.

If previous settings have been saved, they can advantageously be Loaded onto the new control board directly. See the section "**7.13 Load and save settings**" page 50 to read more about the function.

For which settings apply to the unit, see separate documentation.

## **6.7 RH / CO2 / VOC sensor inputs**

Controller supports connection of 1 sensor. Additional 2 sensors can be connected via expansion board. Each input can handle 1.5W (2VA).

Controller support RH sensors with following criteria:

Description		Value
Signal output		0-10V
%RH	Output 0V	0% RH
	Output 10V	100% RH

Controller support CO2 sensors with following criteria:

Description		Value
Signal output		0-10V
CO2	Output 0V	0 PPM CO2
	Output 10V	2000 PPM CO2

Controller support VOC sensors with following criteria:

Description		Value
Signal output		0-10V
VOC	Output 0V	0% VOC
	Output 10V	100% VOC

### 6.7.1 Digital Inputs

#### Main Board

Digital inputs for D1 – D7

- Pull-up to 3.3VDC

#### Expansion board

Digital inputs for D8 – D9

- Pull-up to 3.3VDC

### 6.7.2 Digital Outputs

#### Main Board

Digital outputs Q4 – Q5

- Floating contact with Normally Open (NO) output in resting mode.
- Drives relay with contacts rated for 230V / 3A (resistive Load).

#### Expansion board

Digital outputs for Q6-Q11

Parameter	Value
Switching power, real max	150 W
Switching power, apparent max	1250 VA
Switching voltage AC max	250 VA
Switching voltage DC max	30 V DC
Current DC continuous max	5 A

## 7 Regulation functions

### 7.1 Startup procedure

The IQC program will use a startup sequence to gradually start up the various functions according to the following:

#### 0 Min

- Initiate startup, opening dampers (30s-120s).

#### 2 Min

- When dampers is open, exhaust fan starts at Std-speed (or VAV-startup value if VAV EF-slave is selected as regulation mode) and run heat recovery wheel at 100% to preheat rotor.

#### 5 Min

- The supply fan starts. The fan speeds are set according to fan speed control. If VAV EF-slave is selected as regulation mode, there is a 30s delay before exhaust fan flow is regulated in relation to supply fan flow + offset.
- Starts temperature regulation.
- Allows heat recovery.
- Allows heating or cooling.

#### 15 Min

- Allows functions:
  - Supply fan speed reduction if supply air is too cold.
  - Summer night cooling.
- Allows all alarms. Alarms delayed to this point is:
  - Low supply air temperature alarm.
  - Low rotor temperature alarm.
  - Supply duct Pressure deviation.
  - Exhaust duct Pressure deviation.
  - Rotor alarm.
  - Filter alarm.

**Note:** Time stamps is calculated with damper opening time set to 120s.

### 7.2 Temperature Regulation

#### 7.2.1 Supply air regulation

Supply air regulation will maintain the desired supply air temperature set through the temperature set point menu or by a Week Scheduler / Holiday Scheduler.

#### 7.2.2 Room and Extract Regulation

When using the Room/Extract Regulation the Room/Extract Regulation PID will control the supply air temperature set point within the supply air temperature limits set through the installation menu.

Desired Room/Extract Temperature is set from the temperature set point menu or by a Week Scheduler / Holiday Scheduler.

### 7.2.3 Room and Extract Regulation with Summer/Winter changeover function

- Summer/Winter changeover function
- Temperature regulation mode Exhaust S/V and Room S/V enable automatic changeover of control type to supply air regulation in wintertime.
- Changeover can be made on temperature criterion, date or via external input.
- When Exhaust S/V is selected, Exhaust regulation will be used in summer mode and Supply regulation in winter mode.
- When Room S/V is selected, Room regulation is used in summer mode and Supply regulation in winter mode.
- When regulation type is set to Exhaust S/V or Room S/V, changeover parameter can be configured. Possible to select between three changeover modes: Date, Temperature, or External input.
- If Temp is selected as changeover, outdoor temperature is used to determine when to switch over to winter mode using three settings, Winter start, Summer start and Time constant.
  - Winter start, given in °C, set the temperature limit for when winter starts. The controller evaluates outdoor temperature and will switch to winter mode if outdoor temperature is constant under Winter start temperature set point for the set Time constant.
  - Summer start, given in °C, set the temperature limit for when summer starts. The controller evaluates outdoor temperature and will switch to summer mode if outdoor temperature is constant over Summer start temperature set point for the set Time constant.
- If Date is selected as changeover, date is used to switch over to winter mode:
  - Winter start, given in YYYY-MM-DD, set the date when to activate winter mode.
  - Summer start, given in YYYY-MM-DD, set the date when to activate summer mode.
- External input can be selected when expansion board is present and activated.
- Input state is configured through peripherals menu in the IQC-Display. It can either be Normally Open (NO) or Normally Closed (NC).
- Change on input will activate winter mode and be kept active as long as input is held in that state. On release summer mode is activated again.
- When Exhaust S/V or Room S/V is selected, a temperature offset factor can be set. This factor only affects supply air regulation in winter.

### 7.2.4 Supply Air Temperature Regulation Modes

The supply air temperature regulation has four modes. The regulation moves to the next mode if the current mode cannot keep the desired supply air temperature.

#### Cooling Mode

- Cooling mode is allowed only if Outdoor temperature is at least 15 °C, a cooler is present (installed and activated in installation menu), and the startup timer allows cooling.
- Cooling PID adjusts the cooling power to maintain the desired supply air temperature in the supply duct. If cool recovery is possible it is set to maximum.
- If temperature in the supply duct is too cold even if the cooling PID is set to zero, or if cooling mode is no longer allowed, the regulation will enter Cold Recovery Mode.

### **Cold Recovery Mode**

- The supply air temperature in the supply duct is regulated by PID controlling the Cold Recovery Efficiency (rotor speed).
- If the cold recovery is set to maximum and temperature in the supply duct is still too high, then the cooling mode is entered, if allowed and if a cooler is present.
- If the cold recovery PID is set to zero (off) and the supply air temperature in the supply duct is still too low, then the Heat Recovery Mode is entered.

### **Heat Recovery Mode**

- The supply air temperature in the supply duct is regulated by PID controlling the heat recovery efficiency (rotor speed).
- If the heat recovery is set to maximum and temperature in supply duct is still too low, heating mode is entered, if allowed and heater is present.
- If the heat recovery PID is set to zero (off) and supply air temperature in supply duct is still too high, cold recovery mode is entered.

### **Heating Mode**

- Heating mode is allowed only if a heater is present (installed and activated in the installation menu), and the startup timer allows heating.
- Heating PID adjusts the heating power to maintain the desired Supply Air Temperature in the supply duct. The heat recovery is set to maximum.
- If the supply air is too warm even if the heating PID is set to zero or heating mode is no longer allowed, the regulation will enter heat recovery mode.

### **Rotor**

- If temperature after rotor is less than 8.0 °C, the rotor will run at 100 % regardless of the regulation mode and other temperatures to prevent too low supply temperatures.

#### **7.2.5 Clean-up procedures (Exercise)**

Clean-up procedures are applied as follow:

#### **HWR Clean-up**

If the rotor has not been running within the Last 24 hours, it will run in full speed for 2 minutes.

#### **Heat and Cool Radiator Valves**

Runs once a week in 4-step.

1. Sets heating radiator valve to maximum and cooling radiator valve to minimum.
2. Sets cooling circulation pump on.
3. Sets heating radiator valve to minimum and cooling radiator valve to maximum.
4. Sets heating circulation pump on.

After clean-up is done, the unit returns to normal operation.

## 7.3 Scheduler

### 7.3.1 Scheduler – week

- Scheduler allows up to 5 programs.
- Program with lower index is prioritized if programs overlap.
- Each program has equal settings described below.
  - Weekdays: Program is started on selected weekdays only.
  - Start time: Time when program starts.
  - End time: Time when program ends.
  - Fan speed: Fan speed to be used.
  - Temp. mode: Temperature set point to be used. If Economy set point is activated you can select between comfort or economy set point, else comfort temperature set point will be used.
  - The temperature set points are found under temperature set point menu.
  - If supply regulation is used, set point temperature will be the desired supply air temperature when program is in use. In other regulation modes, the temperature will be the targeted room or extract air temperature.

Weekdays are the days when program starts. If the end time is less than start time, the end time will be on next day. It is not possible to have single program that starts on Friday 22:00 and ends on Monday 06:00.

E.g: Weekdays = Mon, Tue, and Thu, start time 22:00 and end time 06:00, the program will be used three times a week. 1) from Monday 22:00 to Tuesday 06:00, 2) from Tuesday 22:00 to Wednesday 06:00, and 3) from Thursday 22:00 to Friday 06:00.

### 7.3.2 Holiday scheduler

- Holiday scheduler allows up to 10 programs.
- Program with lower index is prioritized if programs overlap.
- Each program has equal settings described below.
  - Start date: Program is started on selected date.
  - End date: Program is ended on selected date
  - Start time: Time when program starts on selected date.
  - End time: Time when program ends on selected date.
  - Fan speed: Fan speed to be used.
  - Temp. mode: Temperature set point to be used. If Economy set point is activated you can select between comfort or economy set point, else comfort temperature set point will be used.
  - The temperature set points are found under temperature set point menu.
  - If supply regulation is used, set point temperature will be the desired supply air temperature when program is in use. In other regulation modes, the temperature will be the targeted room or extract air temperature.

## 7.4 Fan speeds

Fans can be set in 4 speed steps shown below:

Step	Fan speed.
Off	Fans off.
Min fan speed	Is set under fan regulation
Standard fan speed	Is set under fan regulation
Max fan speed	Is set under fan regulation

Under fan regulation the fan speed can be adjusted for each step.

Fans can be controlled either by user, week- and holiday schedules and/or with demand control via RH/CO<sub>2</sub>/VOC sensors.

### User

Unit is always applying standard fan speed when nothing else applies. There are four functions that can be used to manually select which specific fan speed that should apply.

- Away mode
- User Boost
- Overpressure
- Extended operation

#### 7.4.1 Away mode

Decreases fan speeds to Min fan speed.

- Away function is activated or deactivated in the IQC-Display or the IQ Control App direct on home screen or by external pulse signal or switch connected on external input on Controller.
- When activated Min fan speed will be applied and stays activated until deactivated via the IQC-Display or the IQ Control App or ext. pulse signal / switch.
- The User Boost, Overpressure and demand control functions can be applied over the Away mode.
- External pulse signal or switch can be used for turn the function on and off.
- Which signal type that is used on away input, can be selected in peripherals menu. Two signal types can be selected: Pulse or switch.
  - Pulse: One momentary pulse on to the external input, will activate the away mode and stay active until deactivated via the home screen or receiving another pulse on external input.
  - Switch: As long as there is a connection active on the external input, the function will remain active. Function can still be activated via the IQC-Display or the IQ Control App, but external input will be prioritized.
- Input state is configured through peripherals menu in the IQC-Display or the IQ Control App. It can either be Normally Open (NO) or Normally Closed (NC).

#### 7.4.2 Boost

Increases fan speeds to Max fan speed for specified period.

- User boost is activated or deactivated in the IQC-Display or the IQ Control App direct on home screen or by external pulse or switch signal connected on external input on Controller.

- When activated Max fan speed will be applied until period expires or deactivated from display or ext. pulse signal / switch.
- User boost settings is made under service menu in the IQC-Display or the IQ Control App.  
Duration: 10-240 Min.
- External pulse or switch can be used to turn function on and off (even if period has not expired).
- Which signal type that is used on the boost input, can be selected in peripherals menu. Two signal types can be selected: Pulse or Switch.
  - Pulse: One momentary pulse to the external input will apply boost until the period expires or function is deactivated via the home screen or receiving another pulse on external input.
  - Switch: As long as there is a connection active on the external input, the function will remain active. Function can still be activated via the IQC-Display or the IQ Control App and run for set period, but external input will be prioritized.
- Input state is configured through peripherals menu in the IQC-Display or the IQ Control App. It can either be Normally Open (NO) or Normally Closed (NC).
- User Boost can be applied over demand control function.
- User Boost is automatically turned off by any of the following:
  - User Boost duration expires.
  - If it is deactivated via the home screen or by an external pulse or a switched signal connected to the external input
  - If the user overpressure is turned on.

### 7.4.3 Overpressure

- Differentiate supply and exhaust fan, to create a temporary overpressure.
- Overpressure is activated or deactivated in the IQC-Display or the IQ Control App direct on the home screen or by external pulse or switch signal connected on external input on controller.
- When activated Overpressure will be applied until the period expires or is deactivated from the IQC-Display or the IQ Control App or an ext. pulse signal. The Overpressure function will differentiate supply and exhaust fan to create a temporary overpressure. First the supply fan will be increased. If the supply fan will reach the limit for the Max fan speed set for the supply fan, then the exhaust fan is lowered until the difference between the fans is equivalent to the set the offset value.
- Overpressure settings is made under the service menu.
- Duration: 5-60 Min. Offset range on output signal: Min: 5% Max: Supply fan Max – Exhaust fan Min.
- Only pulse signal type can be used.
  - One momentary pulse to the external input will apply overpressure until the period expires or the function is deactivated via the home screen or receiving another pulse on the external input.
  - Note: Even if there is a connection still active (e.g. switch used instead) on the external Overpressure input, the function will only be active the period set for Overpressure. Then the external Overpressure input needs to be retriggered to allow the function to activate again thru that input.
  - Overpressure function have a 5 sec off delay to allow input to be recycled without interruption in overpressure function.
- If input is cycled within active period, function will start on new duration.

- Input state is configured through the peripherals menu in the IQC-Display or the IQ Control App. It can either be Normally Open (NO) or Normally Closed (NC).
- Overpressure have priority over demand control function.
- Overpressure is automatically turned off by any of the following:
  - Overpressure duration expires.
  - If it is deactivated via the home screen or receiving another pulse on the external input.
  - If user boost is turned on.
  - If a water heating coil is installed and the water temperature in the return pipe falls below set point for Freeze limit B.
  - If rotor temperature falls below 8.0°C.

#### **7.4.4 Extended operation**

Wakes the unit from a scheduled standby or increases fan speeds from Min fan speed to Standard fan speed for a specified period.

- Extended operation is activated or deactivated in the IQC-Display or the IQ Control App direct on the home screen or by an external pulse or a switched signal connected on an external input on the controller.
- Extended operation has priority over the Scheduler. When activated a unit in scheduled standby will be started up and Standard fan speed will be applied until the period expires, is deactivated by the IQC-Display, is deactivated by the IQ Control App or an ext. pulse signal / switch.
- If the unit is running in away mode, Standard fan speed will be applied until the period expires, is deactivated by the IQC-Display, is deactivated by the IQ Control App or an ext. pulse signal / switch.
- External pulse or switch can be used to turn the function on and off (even if the period has not expired).
- Which signal type that is used for the Extended operation input, can be selected in the peripherals menu. Two signal types can be selected: Pulse or Switch.
  - Pulse: One momentary pulse to the external input will apply boost until the period expires or function is deactivated via the home screen or receiving another pulse on the external input.
  - Switch: As long as there is a connection active on the external input, the function will remain active. The function can still be activated via the IQC-Display or the IQ Control App and run for set period, but the external input will be prioritized.
- Input state is configured through the peripherals menu in the IQC-Display or the IQ Control App. It can either be Normally Open (NO) or Normally Closed (NC).
- User Boost, Overpressure and demand the control function can be applied over Extended Operation.
- The Extended Operation is automatically turned off by any of the following:
  - The Extended operation duration expires.
  - If it is deactivated via the home screen or by an external pulse or a switch signal connected on the external input.

#### **7.4.5 Demand control via RH/CO2/VOC sensors**

Demand control via an active sensor. If the limit value is exceeded, the Supply and Exhaust air flow will be stepless increased. Max increase of the fan speed will be limited by the settings for Max fan speed.

When more than one transducer is used, the greatest value is prioritized.

## 7.5 Alarms and limits

The unit has a specific alarm handling to be run by a specific condition or to prevent the unit to be damaged, due to failures that could occur. Actions taken upon specific alarm is listed below.

Alert	Delay	Default alarm class	Unit off?	Condition
Fire Alarm	No	A	Yes (4)	Fire input activated. See Fire Alarm
Sensor Open	No	A (5)	Yes	Any of used temperature sensors circuit is open.
Sensor Shorted	No	A (5)	Yes	Any of used temperature sensors circuit shorted.
Freeze Protection	No	A	Yes	Temperature read from freeze protection sensor is lower than Freeze limit A
Low supply temperature	30s (3)	A (5)	Yes (2)	Temperature read in supply duct is lower than supply cold limit A
Low rotor temperature	30s (3)	A (5)	Yes (2)	Temperature read from rotor sensor is lower than supply cold limit A
EC Fan failure (Tacho)	30s	A (5)	Yes	Measured speed < 200 RPM.
EC Fan failure (alarm)	30s	A (5)		Fan alarm output reports failure.
Overheat protection	10s	B (5)	No	No Load on pulser or no pulser connected to the Controller.
Rotor failure	60s (3)	B (5)	No	No rotor pulse detected within 60 seconds. Only time when rotor should run is taken in account and duty cycle is higher than 10%.
Pump alarm	5s	B (5)	No	Pump alarm input activated. See Pump alarm.
Duct Pressure deviation	30s (3)	B (5)	No	Pressure set point value not reached. See Duct Pressure deviation alarm.
Flow deviation	30s (3)	B (5)	No	Pressure set point value not reached. See Flow deviation alarm.
Filter (1)	30s (3)	B (5)	No	See Filter monitoring.
Filter timer	No	B (5)	No	See Filter timer.

### Notes:

1. Filter alarms is combined into one alarm.
2. If also rotor failure applies, otherwise no (when B level is selected).
3. After startup delay has passed.
4. Possible automatic reset.
5. There is an ability to change the alarm class in the Setup menu in the IQC-Display or the IQ Control App.

Temperature alarms are based on four adjustable limits and one constant limit. Limits and their range and usage are listed in table below:

Setting	Min	Max	Usage
Supply cold B	5°C or (Supply cold A + 1)	12°C	Supply fan speed reduction.
Supply cold A	2°C	10°C or (Supply cold B - 1)	Low supply temperature and Low rotor temperature alert.
Freeze limit B	8°C	15°C	Water heater valve fully open.
Freeze limit A	5°C	10°C	Freeze alarm and Water heater valve fully open.
Rotor warning	8°C	8°C	Turns off Overpressure.

### 7.5.1 Alarm actions

Action	Delay	Condition
Reduce Supply fan speed according to Supply temperature fan reduction	No (1)	The temperature read in the Supply duct is lower than Supply cold B or the temperature read from the Rotor sensor is lower than the Supply cold B, or the Rotor failure alarm is active and not reset.
Rotor runs at 100% regardless regulation mode and other temperatures.	No	Temperature read from the Rotor sensor is lower than 8.0 °C
Overpressure off.	No	The temperature read from the Rotor sensor is lower than 8.0 °C or the temperature read from the Freeze protection sensor is lower than Freeze limit B
Water heater valve full open.	No	The temperature read from the Freeze protection sensor is lower than Freeze limit B

#### Notes:

1. After startup delay has passed.

### Supply temperature fan reduction

- Supply temperature fan reduction parameters can be set under alarm parameters in the installation menu.
- Function will be activated if the temperature read in the Supply duct is lower than the Supply cold B or the temperature read from the Rotor sensor is lower than Supply cold B.
- The Supply temperature fan reduction will differentiate Supply and Exhaust fan speed to create a greater flow difference resulting in a higher temperature efficiency over the Heat recovery exchanger. First the supply fan speed will be decreased. If the Supply fan will reach the limit for the Min fan speed set for supply fan, then exhaust fan speed is increased until the difference between the fans is equivalent to the Set fan reduction value.
- Offset range on output signal: Min: 10% Max: Exhaust fan Max – Supply fan Min.
- If fan regulation mode CPC is used, Supply temperature fan reduction is applied upon current output signal for fans.
- The User Boost, Overpressure and demand control functions can be applied over the Away mode.
- The function will deactivate and return to normal operation if the temperature read in the Supply duct is higher than Supply cold B or the temperature read from the Rotor sensor is higher than Supply cold B.

## Freeze protection

- Settings are configured under alarm parameters in the installation menu.
- Three Parameters is set: Freeze limit A, Freeze limit B and Holding temp.
- Freeze protection function reads the value from the Freeze protection temperature sensor T5.
- Either if the unit is in operation or in standby mode, the return water temperature is constant monitored and compared against the Freeze protection limit set points, to prevent freeze damage to the coil and even stop the unit if it's necessary.
- Will have two different functions depending on whether the unit is in standby or in operation.
- Standby:
  - When the unit is in standby mode the Water heating coil is kept at a holding temperature set point to prevent freeze damage to coil.
  - The Water heater valve will be fully open if the temperature read from the Freeze protection sensor is lower than Freeze limit B.
- In operation:
  - The Water heater valve will be fully open if the temperature read from the Freeze protection sensor is lower than Freeze limit B.
  - The unit stops if the Water heater valve will be fully open and if the temperature read from the Freeze protection sensor is lower than Freeze limit A.
- Startup of the unit is only possible if the temperature of T5 is higher than Freeze limit B + 3 K and the alarm is reseted.

The temperature set points can be set as follows:

Setting	Min	Max	Usage
Holding temp.	10°C or (Freeze limit B +1)	30 °C	Low supply temperature and Low rotor temperature.
Freeze limit B	8 °C or (Freeze limit A + 1)	15 °C	Supply fan speed reduction according to Supply temperature fan reduction.
Freeze limit A	5 °C	10 °C	Freeze alarm and Water heater valve full open.

Fire alarm parameters:

- The unit can be configured to run in certain fire scenario when receiving input signal on fire input. Settings are configured in Alarm parameters in the Installation menu.
- Sensor type is configured to be either: Not installed, Normally Open (NO) or Normally Closed (NC).
- Fire mode will have four different modes:
  - Fans off: Both fans are off and dampers are closed.
  - Exhaust fan only: The Dampers are open and the Exhaust fan runs on set forced fan speed. The Supply fan is kept off.
  - Supply fan only: The Dampers are open and the Supply fan runs on set forced fan speed. The Exhaust fan is kept off.
  - Both fans: The Dampers are open, both the fans are operating on individual forced fan speed.
- When any fan is enabled by the Fire alarm function, they run on Forced fan speed.
- Any settings in the EC fan setup are overridden.

### 7.5.2 Fire Alarm Auto Reset

It is possible to enable an auto reset function along with the Fire alarm function, which reset and restarts the unit automatically after the Fire alarm input is reset to normal state. This will allow the system to automatically start up after an fire alarm, without the need of reset the alarm manually via the IQC-Display or the IQ Control App.

#### Duct Pressure deviation alarm

- Alarm is raised if the Pressure read in duct is below 1 Pa for over 60 sec.
- The alarm is displayed for each side, and clarifying which side that is deviating in Pressure.

#### Flow deviation alarm

- Alarm is raised if the output to fans is equal to the Max speed settings and the Flow set point value is still not reached and maintained within 60 sec.
- The alarm is displayed for each side, and clarifying which side that is deviating in Pressure.

#### Pump alarm

- Input state is configured through the peripherals menu in the IQC-Display or the IQ Control App. It can either be Normally Open (NO) or Normally Closed (NC).
- The Heating pump and the Cooling pump is configured separately.
- The Alarm is raised if any pump alarm input is activated for more than 5 sec.

## 7.6 Fan regulation

The Controller supports EC-fans which can be controlled via 0-10V signal. The airflow can be controlled using different modes. The different modes that can be used is:

- %: Setting of fixed output signal to fans.
- CPC: Constant Pressure control
- CAV: Constant Air Volume
- VAV (SA Slave): Variable Air Volume with slave-controlled supply air fan.
- VAV (EA Slave): Variable Air Volume with slave-controlled exhaust air fan.

### 7.6.1 Percent (%)

- Used to set fixed output signal to the fans. The airflow is adjusted using the setup pages for each fan speed.

### 7.6.2 CPC

- Is used to maintain a constant Pressure in the duct. Regulates the fan output signal to compensate for clogged filters, maintaining the same pressure and therefore the same air volume.
- Settings of the reference Pressure setpoints is done under the setting page **[CPC setup]** for standard fan speed.
- It is important that new filters are installed before saving the Reference Pressure setpoints!

#### Note:

- This regulation mode requires the Duct Pressure sensors to be installed and activated.
- The CPC regulation mode cannot be used together with VAV dampers.

### 7.6.3 CAV

- Used for flow regulation of the fans. Flow rate is set directly between 0-9999 in flow unit l/s.
- Actual flow value from the fans is calculated with the formula:  $[q=k*\sqrt{\Delta Pa}]$  where  $\Delta Pa$  is the Pressure measured by the sensor and k is the k-factor given for the fan (specified in the K-factor setting under [Peripherals / Pressure / Flow]).
- Note: This regulation mode requires the Flow Pressure sensors to be installed and activated.

### 7.6.4 VAV (Supply Air (SA) Slave):

- Used to maintain a constant Pressure in extract duct.
- The supply air fan is slave-controlled against the exhaust fan, where the supply air fan flow is regulated in relation to the exhaust fan flow with a defined offset.
- Actual flow value from fans is calculated with the formula:  $[q=k*\sqrt{\Delta Pa}]$  where  $\Delta Pa$  is the Pressure measured by the sensor and k is the k-factor given for the fan (specified in the K-factor setting under [Peripherals / Pressure / Flow]).

**Note:**

This regulation mode requires duct- and flow Pressure sensors to be installed and activated.

VAV Setpoint mode:

In the case of control mode VAV, the setpoint mode is used when adjusting flows can be selected.

- %: The output signal for the fan is set in % and is then saved as a Reference Pressure setpoint.
- Pa: The Pressure setpoint is set directly to the desired value.

VAV Offset mode:

With the control type VAV, offset type can be selected.

- Static: The Offset for the slave-controlled fan can be set individually for all three fan speeds.
- Relative: The Offset for the slave-controlled fan is automatically calculated for Min and Max speed based on ratio in Standard fan speed.

### 7.6.5 VAV (Exhaust Air (EA) Slave)

- Is used to maintain a constant Pressure in the supply duct.
- The exhaust air fan is slave-controlled against the supply fan, where the Exhaust air fan flow is regulated in relation to the supply fan flow with a defined offset.
- During start up, the exhaust fan is run at a startup setpoint until the supply air fan is started and can provide a reference for the exhaust fan. Setpoint is set in % signal output. Regulation of exhaust air with a given offset start when the supply air fan has been active for 30s.
- Actual flow value from the fans is calculated with the formula:  $[q=k*\sqrt{\Delta Pa}]$  where  $\Delta Pa$  is the Pressure measured by the sensor and k is the k-factor given for the fan (specified in the K-factor setting under [Peripherals / Pressure / Flow]).

**Note:** This regulation mode requires the duct- and flow Pressure sensors to be installed and activated.

VAV Setpoint mode:

In the case of control mode VAV, the Setpoint mode used when adjusting flows can be selected.

- %: Output signal for the fan is set in % and is then saved as a Reference Pressure setpoint.
- Pa: The Pressure setpoint is set directly to the desired value.

VAV Offset mode:

With control type VAV, offset type can be selected.

- Static: The Offset for the slave-controlled fan can be set individually for all three fan speeds.
- Relative: The Offset for the slave-controlled fan is automatically calculated for Min and Max speed based on ratio in Standard fan speed.

### 7.6.6 Standard fan speed setup page

When entering the setup page, all program parameters that affect the flow of the fans are temporarily deactivated and the program is entering adjustment mode. When leaving the setup page, the unit returns to normal operation.

The standard fan speed is the position where adjustment of the ventilation system shall be made. The supply and exhaust air flow can be adjusted individually.

When CPC and VAV is used:

Adjusting the % setting so the correct air flow is obtained. Wait until the Pressure reading in the duct has stabilized to the %-values before saving new Pressure setpoints.

### 7.6.7 Min and Max speed setup pages

When entering the setup page, all program parameters that affect the flow of the fans are temporarily deactivated and the program is entering adjustment mode. When leaving the setup page, the unit returns to normal operation.

The exhaust air flow can be adjusted. The supply air flow is calculated automatically based on the ratio of the Standard fan speed. In the case of VAV regulation with static offset, the supply and the exhaust air flow can be set individually.

**Note:** The output signal to the fans will never go below 1.0V even if the output signal value from the Fan regulator can be lower.

### 7.6.8 Flow direction

For the units that can be changed to be either right-hand or left-hand versions, the correct flow direction must be selected. Standard is used for right versions and Møtsatt is used for left versions.

The controller will automatically reassign the function of the internal temperature sensors according to the selected flow direction to allow the supply and exhaust ducts to be connected to the Møtsatt side of the unit.

### 7.6.9 Flow display

This setting is available if the Flow sensors are installed and activated. Allows selection of the flow unit when presenting flow on the advanced home screen.

If set to None, the unit for the selected control type (% or Pa) is displayed instead.

## 7.7 Alarm relays

The units that are equipped with a full-scale expansion board has the possibility to utilize alarm relay outputs to the Monitor unit status.

There are 3 alarm relay outputs available on the expansion board.

- The first is state changed on any A-level alarms.
- The second is state changed on any B-level alarms.
- The third is state changed when no A- or B-alarm is active.

When the unit is not powered the relays is not energized. (Will be in Normally Open state)

When the unit is operating, the relay is set to state configured either Normally Open (NO) or Normally Close (NC). Configured state applies to the relay output when there is no active relay state change.

Which alarms that should be outputted on the alarm relay outputs is set under the **[Alarm parameters /Alarm relay alerts]**.

## 7.8 Night cooling (NC)

Night cooling is a temperature-controlled boost taking advantage of the cool outside air and thus cooling down the indoor air. This function is therefore most efficient during evenings/night-time. When it's activated, the fans will run at Max fan speed and heat recovery will be temporarily deactivated.

- The Night cooling is activated and is in operation ONLY if the following conditions are met:
- The temperature criterion In/Out diff. must be true together with the Exhaust air High in order for function to be activated.
- The function remains active until the temperature criteria for the Exhaust Air Low is met or In/Out diff. is no longer true.

**Note:** User Boost and Overpressure will have a higher priority than the night cooling, that means that night cooling will be deactivated if Boost or Overpressure is active.

If Night cooling is enabled, Water cooling is disabled even if the Cooling coil is installed and activated.

### Standby Temp. Evaluation

When the unit is in standby and Night cooling is enabled, night exercise function can be used to check if cooling is required. For the set interval time, the unit does an exercise run for set time. If cooling is required, the unit runs the set Min. run time before a new evaluation is done.

- Interval: Time between evaluations. Can be set between 1-4hour.
- Evaluation time: Runtime for updating temperatures. Can be set between 5-15min.
- Minimum operating time: If there is a need for running night cooling, the minimum operating time is set before the plant will go back to hibernation. Can be set between 30-120min.

## 7.9 Temperature setpoint

Temperature setpoints can be set from the home screen.

If Economy setpoint is activated you can set comfort and/or economy setpoint, else only comfort temperature setpoint will be available.

Comfort setpoint is the temperature that the unit will use when no other function such as week schedule is active. Economy setpoint is only used with week and holiday schedules.

If only comfort temperature setpoint is used it can be set as low as 15°C and as high as setpoint max limit.

When using comfort and economy temperature setpoint, setpoints cannot overlap each other but can be set as follow:

Comfort: 15°C or (Economy+1°) to setpoint max-limit, Economy: 15° to (Comfort-1°)

If supply temperature regulation is used, the set temperature will be the desired supply air temperature. In other regulation modes, the set temperature will be the targeted room or extract air temperature.

## 7.10 Temperature setpoint max limit

Setting to set a limit for the maximum temperature setpoint. Setting the max limit to a lower value than currently comfort setpoint will automatically set comfort setpoint to the highest allowed max limit.

If the temperature setpoint is set to a higher value than the temperature limit allows, the temperature setpoint will automatically limit to the highest allowed value.

If the after heater type is configured to Electric, the max limit can be set to 40°C.

**Warning!** The highest recommended limit is 35°C, higher value (or lower air flows) can cause overheating.

If the after heater type is configured to Water or PAC-IF013, the max limit can be set to 60°C.

## 7.11 Fallback management

In the event of lost communication to expansion boards or to Pressure sensors that are controlled via modbus, the control will enter a fallback management.

It starts after 30s of lost communication and alarm is issued. This applies regardless of startup or normal operation. The controller regulates according to the most recent known values until communication is restabilized.

## 7.12 Filter monitoring

Which type of filter measurement mode that is to be used is set under the Filter monitoring menu.

If a filter alarm is given and reseted but no action changing filter has been done, a reminder will pop up the next day at 12.00 until the filter has been changed. If the filter measurement mode is set to Period, a new service period needs to be started.

### 7.12.1 Type of filter measurement mode that can be used

#### Period

- Selected by default.
- Gives an alarm notification at 12:00 when the filter period has expired. The period can be set between 1-12 months.
- Days left can be seen in the [home screen advanced].
- With a reset, a new service period is started.

#### Diff. switch

- Requires a Pressure switch to be installed.
- Scheduled filter measurement at a selected time and day. At every measurement the unit will run the fans at Max fan speed for one minute.
- The current value is displayed in the home screen advanced.
- An alarm will only be given when the Pressure has exceeded the limit for 30s during a test.
- The Diff. Switch choice will be unavailable if the function Emergency stop / Service switch is used, and a full-scale expansion board is not present.
- Function only compatible with units that have Pressure outlets.

#### Diff. sensor

- This filter measurement mode requires filter Pressure sensor to be installed and activated.
- Scheduled filter measurement at a selected time and day. At every measurement the unit will run at standard speed and check if the Pressure at both the exhaust and the supply filter will exceed the set limit. Alarm is given if the Pressure exceeds the limit for 30 seconds.
- Measured only when the fans are running at standard speed, no boosts etc. applied.
- The current value is displayed in the home screen advanced.

### Speed increase

- Requires a duct sensor to be installed and activated, also the fan regulation mode to be set to CPC.
- The Speed increase allows you to use the output signal of the fans as a reference when measuring the filter clogging. The limit value for the filter alarms is the saved reference value of the fans increased by the set value for the speed increase. When the output signal for the fans has exceeded the speed increase value a filter alarm is given.
- The Filter clogging percentage is shown in the home screen advanced and refers to how much of the allowed speed increase that has been met.
- For example, if the speed increase is set to 10% and the fans have increased by 5% in signal output compared to its saved reference value, the percentage for the filter clogging will show 50% in the home screen advanced.
- An alarm is given when the speed increase has been exceeded to maintain the set setpoint.
- The current value displayed in the home screen advanced is not affected by the fan speeds other than the Standard speed.

### 7.13 Load and save settings

- The Save function means that all settings that have been configured in the IQC-Display or the IQ Control App can be saved. In this way, you can use the Load function to retrieve all the previously saved settings that were made. This function can be of great use when a previous control board have been replaced by being able to easily Load back all the previously saved settings directly onto the new control board.
- Reset all parameters means that all configured settings are reset back to the default settings which the unit was delivered with.

# Appendix 1 IQC – Installation Wizard

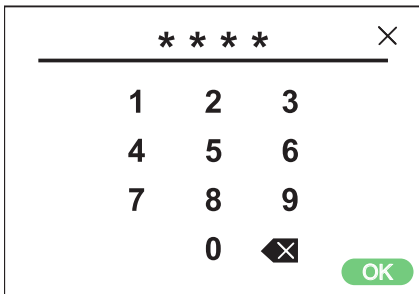

Service input code 1991

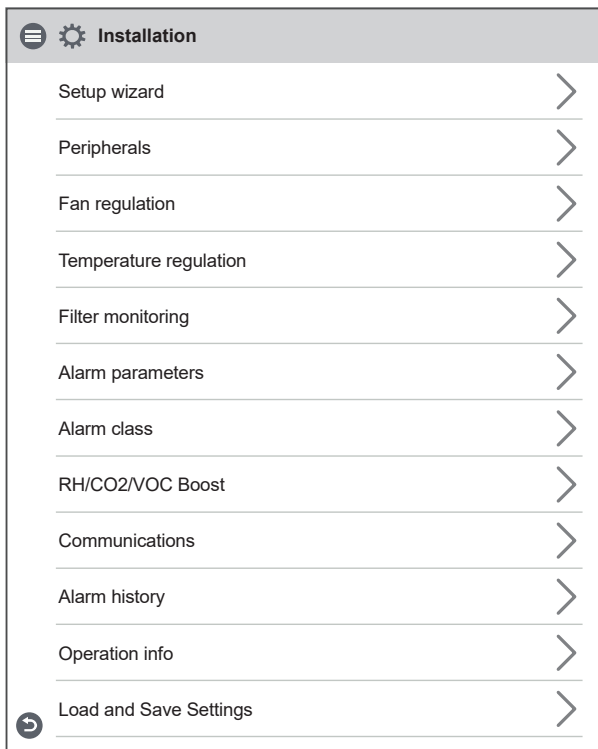

Installation – wizard.

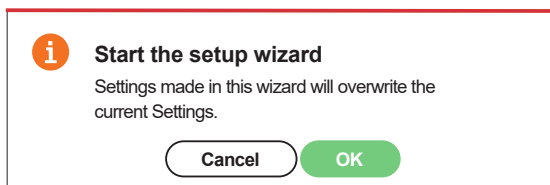

Wizard

## 1.1 Step 1 – RH/CO2/VOC Boost

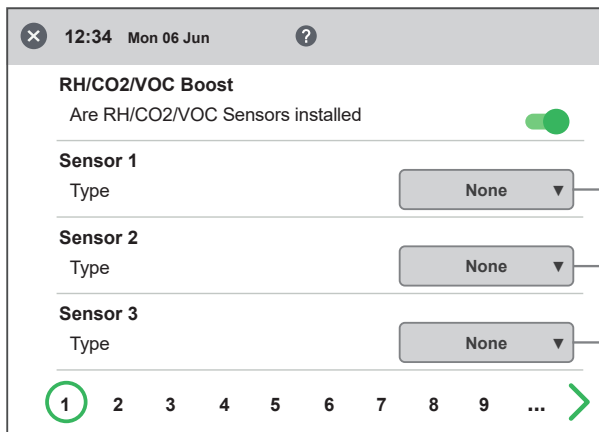

Wizard – 1

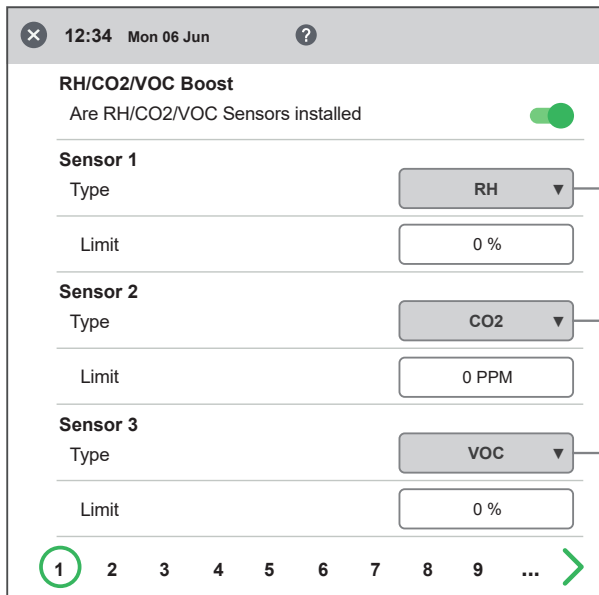

Wizard – 1 – with sensors active

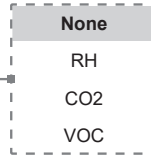

### Sensor type

Select the type of sensor and set the limit value for when fan compensation will activate.

If the limit value is exceeded, the supply and exhaust air flow will be increased steplessly.

When using more than one sensor, the value that is greatest is prioritized.

Sensor 2 and 3 is only visible when a expansion board is installed and activated.

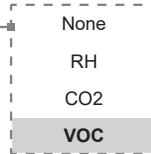
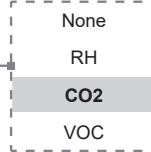
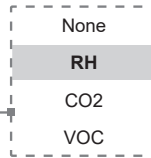

## 1.2 Step 2 – Heating and cooling

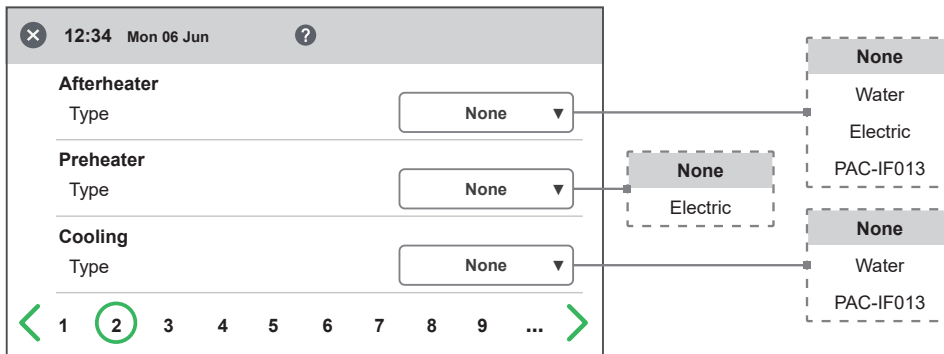

Wizard – 2 – After heater

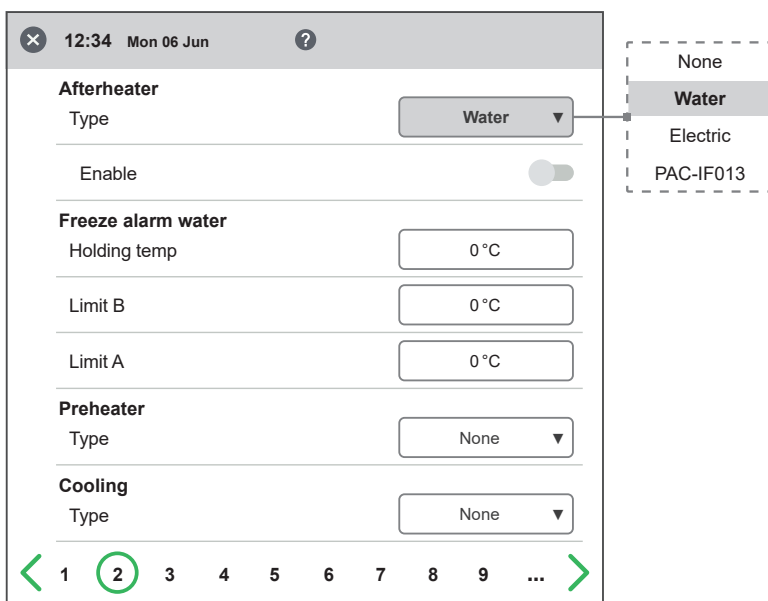

Wizard – 2 – After heater / Water

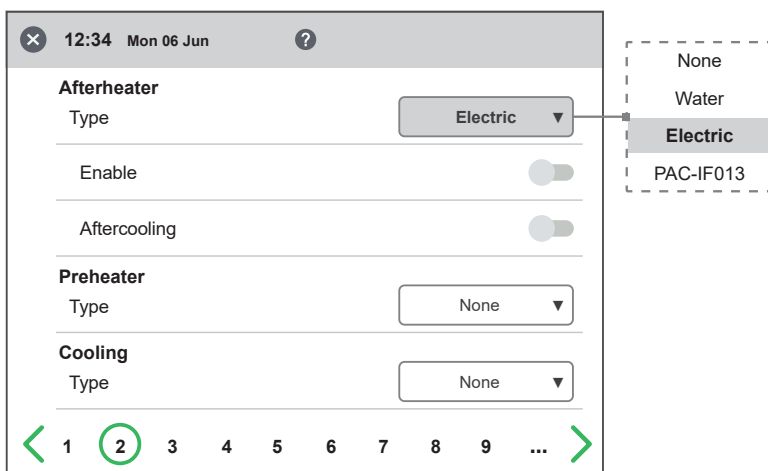

Wizard – 2 – After heater / Electric

### After Heater

Selection of which type of after heater that is installed. For water, freeze protection parameters can be set:

- Hold temperature: When the plant is switched off, the water coil is kept warm so that the return water temperature is the same as the holding temperature set point.
- Limit B: Temperature limit value where heat valve is forced to full open.
- Limit A: Temperature limit where also the plant is stopped if it is in operation.

For electric heater, after-cooling function can also be set.

### Pre-heater

Selection of which type of pre heater that is installed. [Temperature set point] is set to when pre-heater is to start support to heat the cold outdoor air.

The pre-heater is controlled against the temperature at the outdoor air filter and is activated when the temperature in the outdoor air falls below the set point.

### Cooling (is only visible with expansion board)

Selection of which type of cooling device that is installed.

12:34 Mon 06 Jun

**Afterheater**  
Type: PAC-IF013  
Enable:

**Preheater**  
Type: None

**Cooling**  
Type: None

1 2 3 4 5 6 7 8 9 ...

None  
Water  
Electric  
PAC-IF013

Wizard – 2 – After heater / PAC-IF013 is only visible with expansion board

12:34 Mon 06 Jun

**Afterheater**  
Type: None

**Preheater**  
Type: Electric  
Enable:   
Temperature setpoint: 0 °C

**Cooling**  
Type: None

1 2 3 4 5 6 7 8 9 ...

None  
Electric

Wizard – 2 – Pre heater / Electric

12:34 Mon 06 Jun

**Afterheater**  
Type: None

**Preheater**  
Type: None

**Cooling**  
Type: Water  
Enable:

1 2 3 4 5 6 7 8 9 ...

None  
Water  
PAC-IF013

Wizard – 2 – Cooling / Water

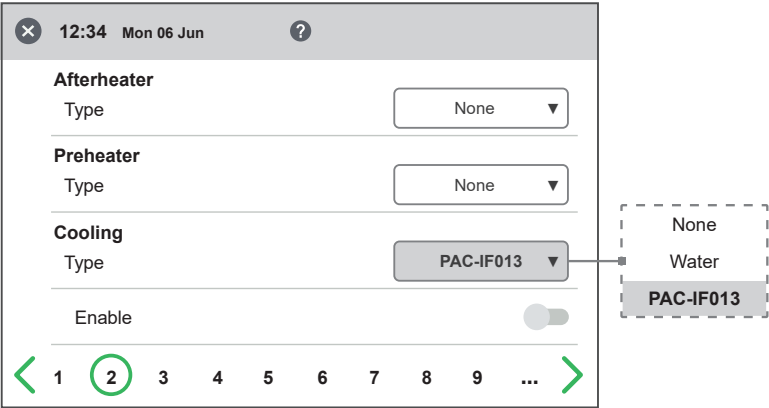

Wizard – 2 – Cooling / PAC-IF013

### 1.3 Step 3 – Temp regulation

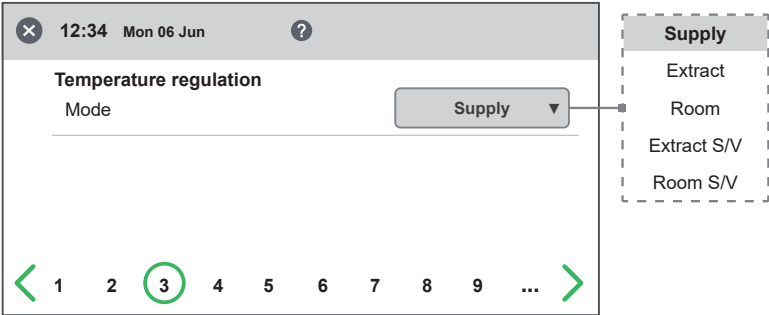

Wizard – 3 Temp regulation / Supply

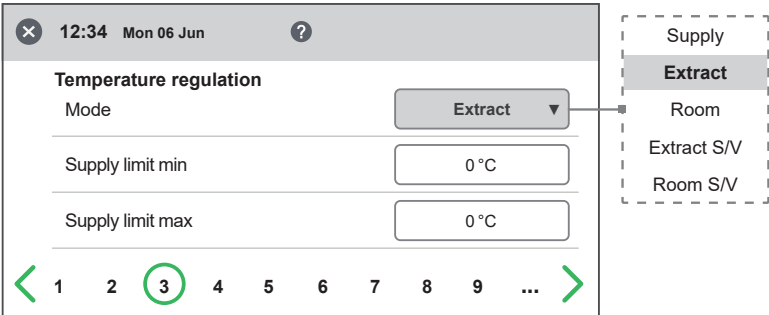

Wizard – 3 – Temp regulation / Extract

#### Regulation Type

- Supply compare the temperature set point against the temperature in the supply air.
- Extract air compare the set point against the temperature in the extract air and regulates the temperature in the supply air between the set Min/Max limits.
- Room compare the set point against temperature from the room sensor and regulates the temperature in the supply air between set Min/Max limits.
- Extract S/V and Room S/V enable automatic changeover of control type to supply air regulation in wintertime.

Changeover can be made on temperature criterion, date or via external input.

When extract S/V or Room S/V is selected, a temperature offset factor can be set. This factor only affects supply air regulation in winter.

12:34 Mon 06 Jun

**Temperature regulation**

Mode: Room

Supply limit min: 0°C

Supply limit max: 0°C

1 2 3 4 5 6 7 8 9 ...

Wizard – 3 – Temp regulation / Room

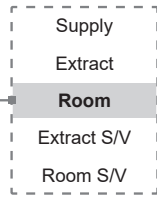

12:34 Mon 06 Jun

**Temperature regulation**

Mode: Extract S/V

Supply limit min: 0°C

Supply limit max: 0°C

Changeover: Temp.

Winter start: 0°C

Summer start: 0°C

Time constant: 0 h

Supply temp. offset: 0 K

1 2 3 4 5 6 7 8 9 ...

Wizard – 3 – Temp regulation / Extract S/V / Temp

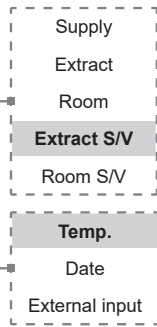

12:34 Mon 06 Jun

**Temperature regulation**

Mode: Extract S/V

Supply limit min: 0°C

Supply limit max: 0°C

Changeover: Date

Winter start: 01-01 (MM-DD)

Summer start: 01-01 (MM-DD)

Supply temp. offset: 0 K

1 2 3 4 5 6 7 8 9 ...

Wizard – 3 – Temp regulation / Extract S/V / Date

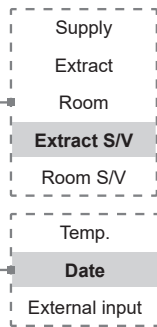

12:34 Mon 06 Jun

**Temperature regulation**

Mode: Extract S/V

Supply limit min: 0 °C

Supply limit max: 0 °C

Changeover: External input

Supply temp. offset: 0 K

1 2 3 4 5 6 7 8 9 ...

- Supply
- Extract
- Room
- Extract S/V**
- Room S/V
- Temp.
- Date
- External input**

Wizard – 3 – Temp regulation / Extract S/V / External input

12:34 Mon 06 Jun

**Temperature regulation**

Mode: Room S/V

Supply limit min: 0 °C

Supply limit max: 0 °C

Changeover: Temp.

Winter start: 0 °C

Summer start: 0 °C

Time constant: 0 h

Supply temp. offset: 0 K

1 2 3 4 5 6 7 8 9 ...

- Supply
- Extract
- Room
- Extract S/V
- Room S/V**
- Temp.**
- Date
- External input

Wizard – 3 – Temp regulation / Room S/V / Temp

12:34 Mon 06 Jun

**Temperature regulation**

Mode: Room S/V

Supply limit min: 0 °C

Supply limit max: 0 °C

Changeover: Date

Winter start: 01-01 (MM-DD)

Summer start: 01-01 (MM-DD)

Supply temp. offset: 0 K

1 2 3 4 5 6 7 8 9 ...

- Supply
- Extract
- Room
- Extract S/V
- Room S/V**
- Temp.
- Date**
- External input

Wizard – 3 – Temp regulation / Room S/V / Date

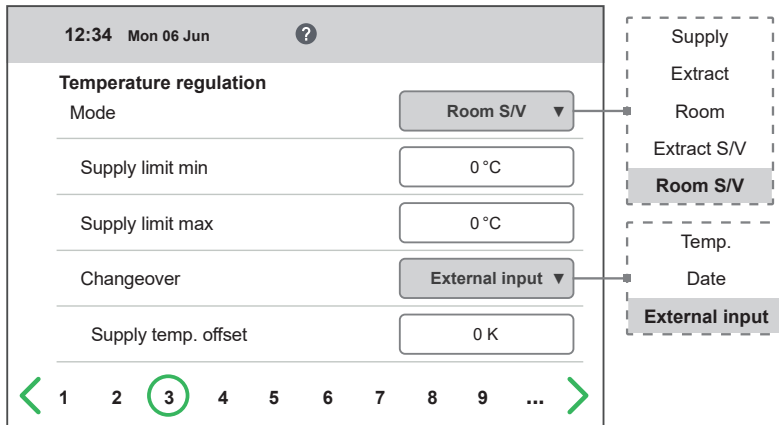

Wizard – 3 – Temp regulation / Room S/V / External input

## 1.4 Step 4 – Temp set point & Supply temp low

### Set point Max limit

Set a maximum limit on the temperature set point setting.

Extra economy temperature set point can be activated, which allows for two temperature set points in the scheduler.

Supply air temperature Low:

- Limit A: Temperature limit when alarms for low supply air temperature will be given.
- Limit B: At which temperature limit the fan reduction will be activated.
- Fan reduction: Reduction of supply air fan. Min 10%, Max % diff. between Max and Min speed.

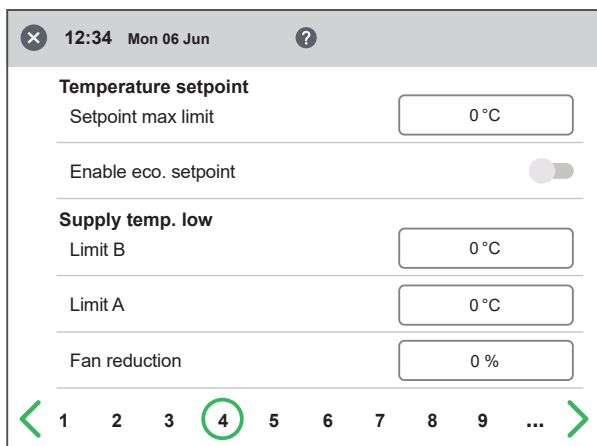

Wizard – 4 – Temp set point

### 1.5 Step 5 – Switches

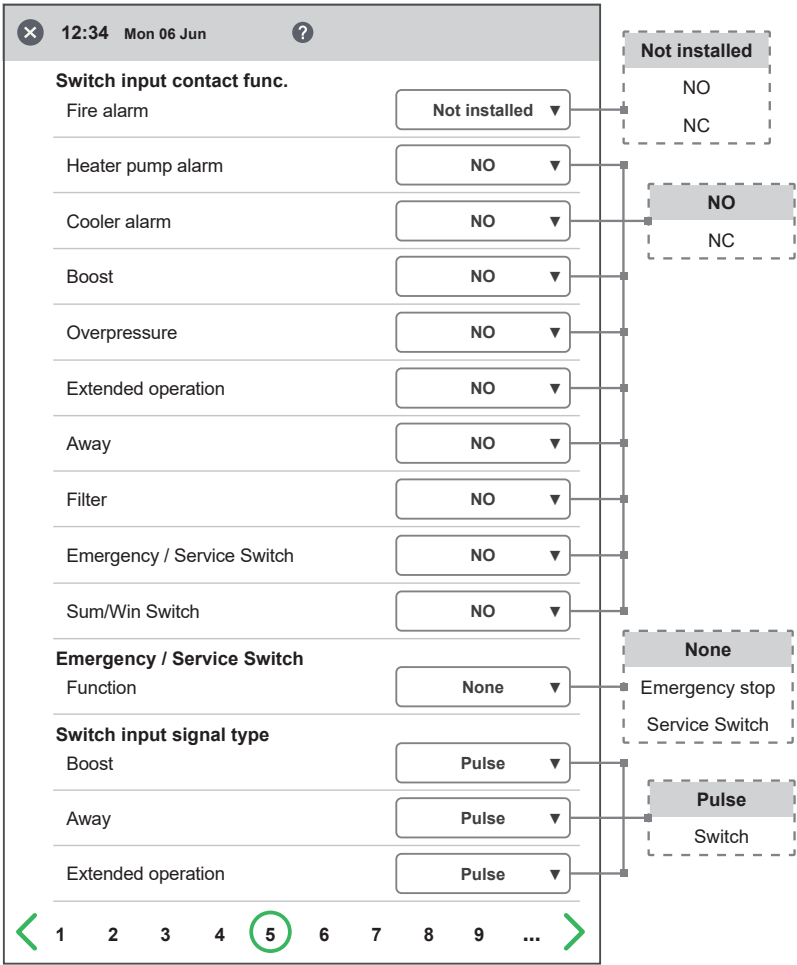

Wizard – 5 – Switches

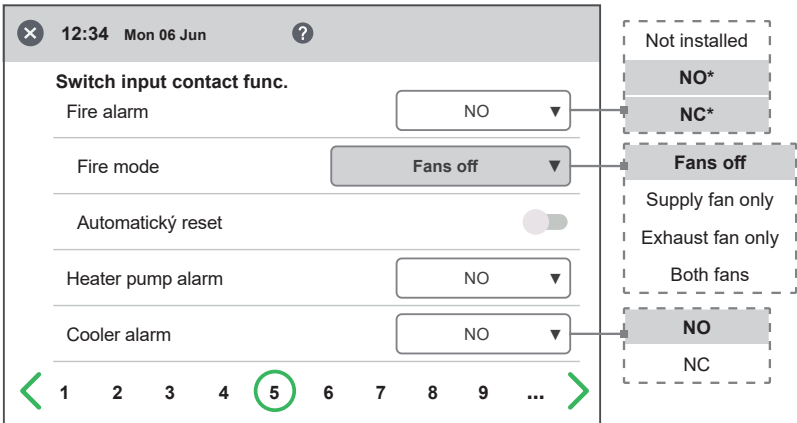

Wizard – 5 – Switches / Reduced menu – Fire alarm / Fans off

#### External inputs – Contact function

Choice of contact function from external equipment.

NO: Normally open, NC: Normally closed.

Fire alarm:

- Fire mode: Function of fans in case of fire alarm.
- Forced speed: If fan is forced into operation, the % output signal will be used.

Automatic reset allows the unit to return to normal operation automatically when the external fire alarm is reset.

#### Emergency Stop / Service Switch (only with mini expansion board installed and activated)

Possibility to use Emergency Stop / Service Switch via input D6. If Expansion board is activated, the function is activated via input D19.

#### External inputs – Signal type

Choice of signal type from external equipment.

- "Pulse" is used for instant contact function.
- "Switch" is used for sustained contact function.

#### Sum/Win Switch (only with expansion board installed and activated).

\* The dynamic menus are same for both NO and NC.

The screenshot shows the 'Switch input contact func.' configuration screen. The 'Fire alarm' dropdown is set to 'NO'. The 'Fire mode' dropdown is set to 'Supply fan only'. The 'Forced Supply fan speed' is set to '0 %'. The 'Automatický reset' toggle is off. The 'Heater pump alarm' dropdown is set to 'NO'. A navigation bar at the bottom shows steps 1 through 9, with step 5 circled in green. To the right, a dashed box contains a list of options: 'Not installed', 'NO\*', 'NC\*', 'Fans off', 'Supply fan only' (highlighted), 'Exhaust fan only', 'Both fans', 'NO', and 'NC'. Arrows point from the 'NO' dropdowns to the 'NO\*' and 'NO' options, and from the 'Supply fan only' dropdown to the 'Supply fan only' option.

Wizard – 5 – Switches / Reduced menu – Fire alarm / Supply fan only

The screenshot shows the 'Switch input contact func.' configuration screen. The 'Fire alarm' dropdown is set to 'NO'. The 'Fire mode' dropdown is set to 'Exhaust fan only'. The 'Forced exhaust fan speed' is set to '0 %'. The 'Automatický reset' toggle is off. The 'Heater pump alarm' dropdown is set to 'NO'. A navigation bar at the bottom shows steps 1 through 9, with step 5 circled in green. To the right, a dashed box contains a list of options: 'Not installed', 'NO\*', 'NC\*', 'Fans off', 'Supply fan only', 'Exhaust fan only' (highlighted), 'Both fans', 'NO', and 'NC'. Arrows point from the 'NO' dropdowns to the 'NO\*' and 'NO' options, and from the 'Exhaust fan only' dropdown to the 'Exhaust fan only' option.

Wizard – 5 – Switches / Reduced menu – Fire alarm / Exhaust fan only

The screenshot shows the 'Switch input contact func.' configuration screen. The 'Fire alarm' dropdown is set to 'NO'. The 'Fire mode' dropdown is set to 'Both fans'. The 'Forced Supply fan speed' is set to '0 %'. The 'Forced exhaust fan speed' is set to '0 %'. The 'Automatický reset' toggle is off. The 'Heater pump alarm' dropdown is set to 'NO'. A navigation bar at the bottom shows steps 1 through 9, with step 5 circled in green. To the right, a dashed box contains a list of options: 'Not installed', 'NO\*', 'NC\*', 'Fans off', 'Supply fan only', 'Exhaust fan only', 'Both fans' (highlighted), 'NO', and 'NC'. Arrows point from the 'NO' dropdowns to the 'NO\*' and 'NO' options, and from the 'Both fans' dropdown to the 'Both fans' option.

Wizard – 5 – Switches / Reduced menu – Fire alarm / Both fans

## 1.6 Step 6 – Alarm class

Alarm class	Selected Class
Sensor open	A
Sensor shorted	A
Overheat protection	A
Supply temp. low	A
Rotor temp. low	A
Fan failure	A
Heat exchanger	A
Duct Pressure deviation	A
Insufficient airflow	A
Heater pump alarm	A
Cooler alarm	A
Filter	A
Filter timer	A

Legend: **A** (solid box), **B** (dashed box)

Navigation: 1 2 3 4 5 **6** 7 8 9 ...

### Settings – Alarm classes

Settings of which alarm class that respective alarm should have.

#### Two levels can be selected

- A-alarm: A critical alarm that will stop the ventilation unit.
- B-alarm: A non-critical alarm that keeps the ventilation unit in operation.

Wizard – 6 – Alarm class

## 1.7 Step 7 – Alarm output & alarm relay

The screenshot displays the 'Alarm output & alarm relay' configuration screen. At the top, it shows the time '12:34' and date 'Mon 06 Jun'. The interface is divided into two main sections:

- Alarm output:** Contains three dropdown menus for 'A-relay state', 'B-relay state', and 'Run-relay state', all currently set to 'NO'.
- Alarm relay alerts:** A list of 17 alerts, each with a toggle switch:
  - Fire alarm
  - Sensor open
  - Sensor shorted
  - Overheat protection
  - Freeze alarm
  - Supply temp. low
  - Rotor temp. low
  - Fan failure
  - Heat exchanger
  - Duct Pressure deviation
  - Insufficient airflow
  - Heater pump alarm
  - Cooler alarm
  - Filter
  - Filter timer

At the bottom, a navigation bar shows steps 1 through 9, with step 7 highlighted in a green circle. A diagram on the right side of the screen shows a dashed box representing an expansion board with 'NO' and 'NC' terminals. Lines connect the 'NO' dropdowns from the 'Alarm output' section to the 'NO' terminal in the expansion board diagram.

Wizard – 7 – Alarm output & alarm relay

### Alarm outputs (only with expansion board installed and activated)

- A-relay state: Contact function during normal operation.
- B-relay state: Contact function during normal operation.
- Run-relay state: Contact function during normal operation.

### Alarm relay alerts (only with expansion board installed and activated)

Which alarms that will affect alarm output. Depending on the alarm class, the A-relay or the B-relay is affected.

## 1.8 Step 8 – Filter measurement

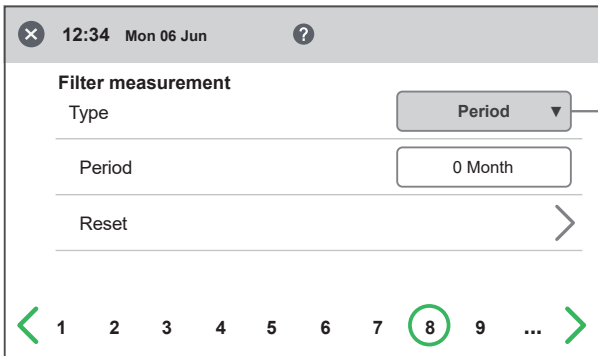

Wizard – 8 – Filter measurement – Period

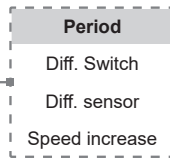

### Filter Measurement

Type of filter control.

- **Period:** Selected by default. Gives an alarm when the service period has expired. Reset starts new service period.
- **Diff. Switch:** Scheduled filter measurement at selected day and time (requires accessories).
- **Diff. sensor:** Scheduled filter measurement at selected day and time. Compare measured value against set final Pressure drop (requires accessories).
- **Speed increase:** In CPC control of fans, the output signal of the fans can be used as a reference when measuring filter clogging. The limit value for filter alarms is the saved reference value of the fans increased by the set value for speed increase. Speed increase means keeping a constant Pressure in the duct by increasing the fans' output signal to compensate for clogged filters (requires accessories).

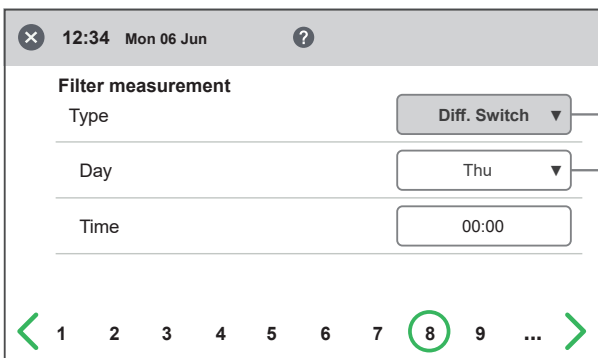

Wizard – 8 – Filter measurement – Diff. switch

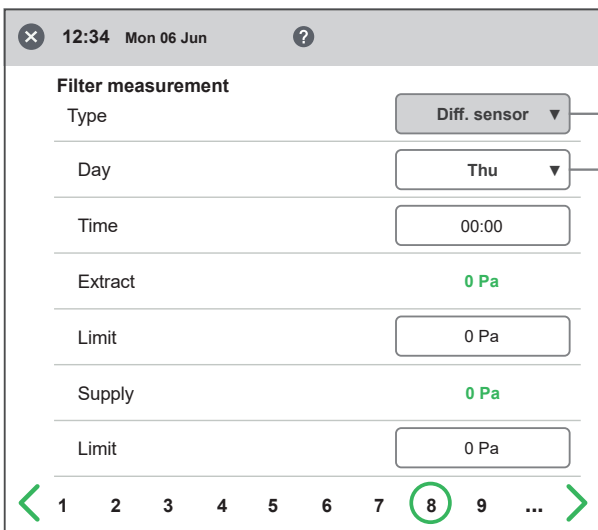
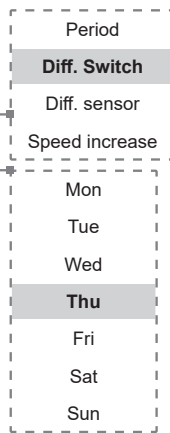

Wizard – 8 – Filter measurement – Diff. sensor

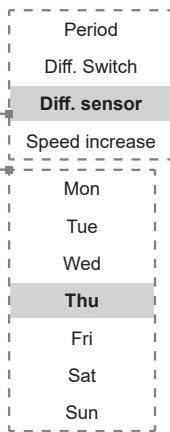

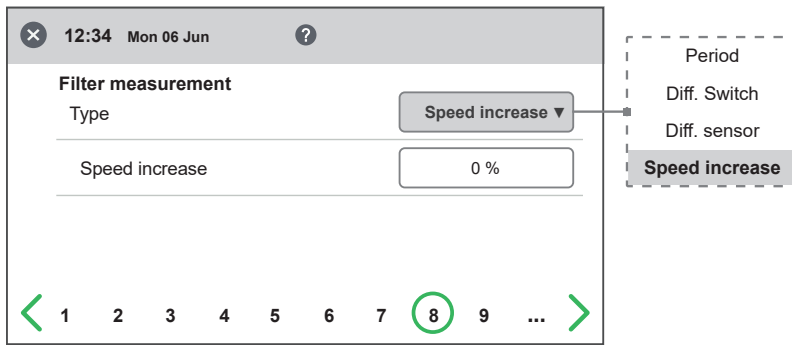

Wizard – 8 – Filter measurement – Speed increase

## 1.9 Step 9 – Pressure range Duct

### Pressure sensor

Settings for duct Pressure measurement with Pressure sensor.

Type: Selection of signal type from sensor. Can be set to 0-10V or Modbus depending on peripherals.

If the sensor type is set to 0-10V, the Pressure range must be selected according to what is set in the Pressure sensor.

If the sensor type is set to Modbus, the Pressure range is set automatically.

Modell: Choice of supported Modell.

Function: Selection of the Pressure sensor operating function. For duct Pressure sensor, individual is always selected.

### Info

- When status is [OK] – Connection to sensor is ok.
  - When status is [--] – There is no communication.
- Real-time information and status from Pressure sensor. The Pressure values GP1 and GP2 are direct actual values from the Pressure sensor.

### Zero-point calibration

When the sensor type is selected to Modbus, you can do Zero-point calibration of the Pressure sensor via display. Alle connected hoses must be disconnected when performing calibration.

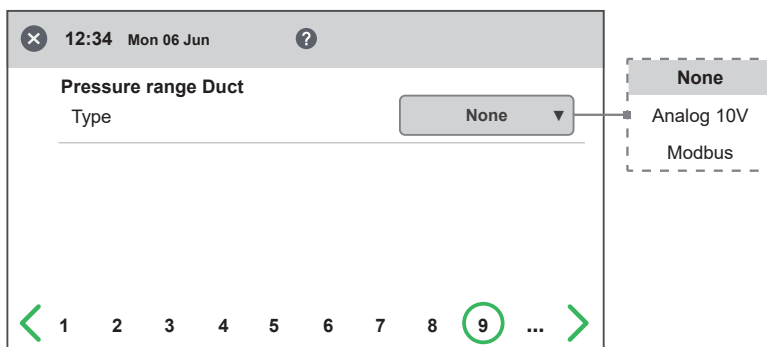

Wizard – 9 – Pressure input duct

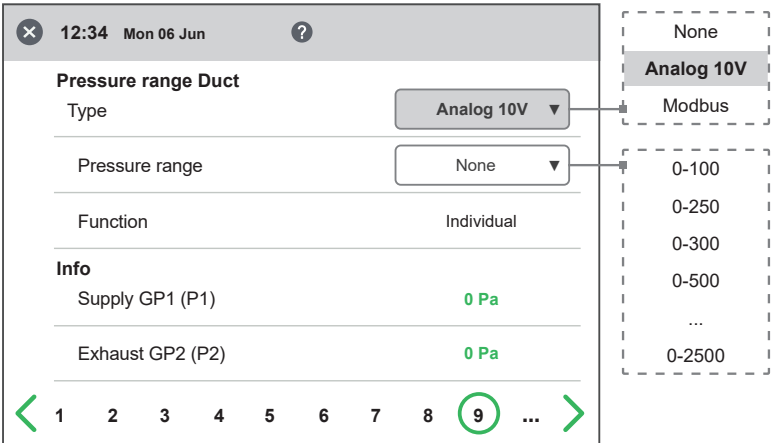

Wizard – 9 – Pressure input duct – Analog 10V

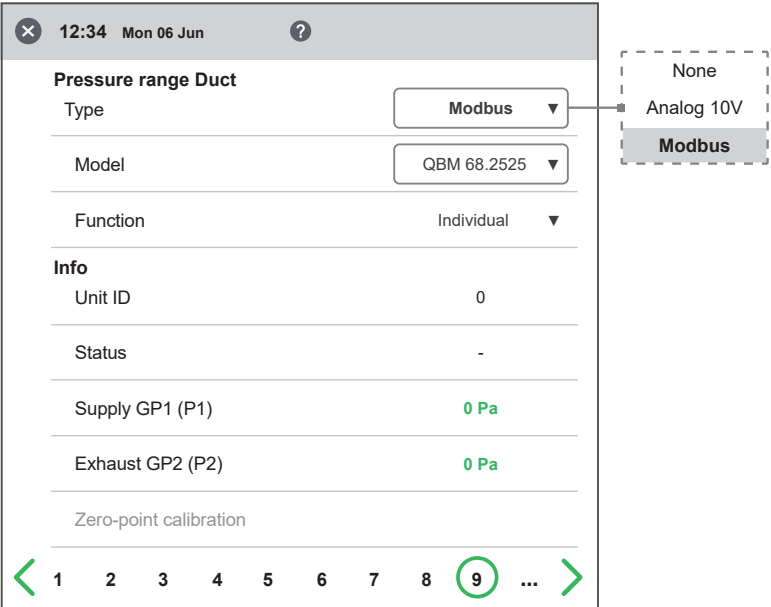

Wizard – 9 – Pressure input duct – Modbus

### 1.10 Step 10 – Dampers

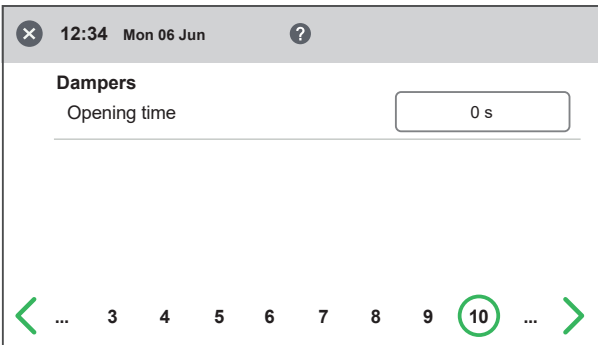

Wizard – 10 – Dampers

#### Damper

Opening time setting for dampers. Acts as start-up delay of the extract air fan to allow time for dampers to open.

For opening times, see separate data sheet for damper motor.

## 1.11 Step 11 – Flow and regulation

### Flow direction

Can be set to Standard or Motsatt. The "Motsatt" setting is only used on ventilation units that have a design that allows the flow direction to be changed. See manual for more details.

### Flow display

Selection of flow unit when presenting flow on advanced home screen. If set to None, the unit for the selected control type (% , Pa) is displayed instead.

### Regulation mode

Selection of fan control mode.

%:

Setting of fixed output signal to fans.

CPC – requires accessories: Used to keep constant Pressure in duct. Regulates fan output signal to compensate for clogged filters. Setting of Pressure setpoints is done under setting page "CPC setup" for standard fan speed.

**It is important that new filters are installed before saving reference setpoints!**

CAV – requires accessories:

Used for flow regulation of the fans.

VAV (SA Slave) – requires accessories:

The supply air fan is slave-controlled against the exhaust fan, where the supply air fan flow is regulated in relation to the exhaust fan flow + offset.

VAV (EA Slave) – requires accessories:

The exhaust air fan is slave-controlled against the supply fan, where the exhaust air fan flow is regulated in relation to the supply fan flow + offset.

### Setpoint mode

In the case of control mode VAV, the setpoint mode used when adjusting flows can be selected.

%:

Output signal for fan is set in % and is then saved as a reference Pressure setpoint.

Pa:

The Pressure setpoint is set directly to the desired value.

### Offset mode

With control type VAV, offset type can be selected.

Static:

Offset for slave-controlled fan can be set individually for all three fan speeds.

Relative:

Offset for slave-controlled fan is automatically calculated for min and max speed based on ratio in Standard fan speed

### Standard fan speed

When entering the setup page, all program parameters that affect the flow of the fans are temporarily deactivated and the program is entering adjustment mode.

When leaving the setup page, the unit returns to normal operation.

The standard fan speed is the position where adjustment of the ventilation system shall be made.

The supply and exhaust air flow can be adjusted individually.

### 1.11.1 Regulation type "Percent (%)"

The screenshot shows the 'Regulation type "Percent (%)'" setup screen. It includes a status bar at the top with the time '12:34' and date 'Mon 06 Jun'. The main settings are:

- Flow Direction:** Standard
- Flow display Type:** None
- Regulation Type:** %
- Standard fan speed:** Setup
- Exhaust:** 0 %
- Supply:** 0 %

A legend on the right side of the screen maps these settings to specific control modes:

- Standard:** Opposite
- None:** l/s, m<sup>3</sup>/h
- %:** CPC, CAV, VAV (SA Slave), VAV (EA Slave)

At the bottom, a navigation bar shows steps 4 through 11, with step 11 highlighted in a green circle.

Wizard – 11.1 – Regulation / %

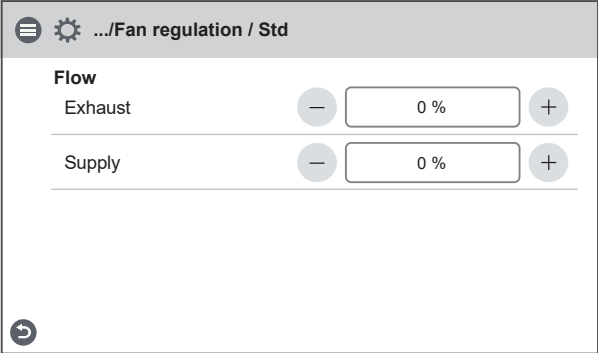

Wizard – 11.1 – Fan regulation “%” / Standard fan speed

### 1.11.2 Regulation type “CPC”

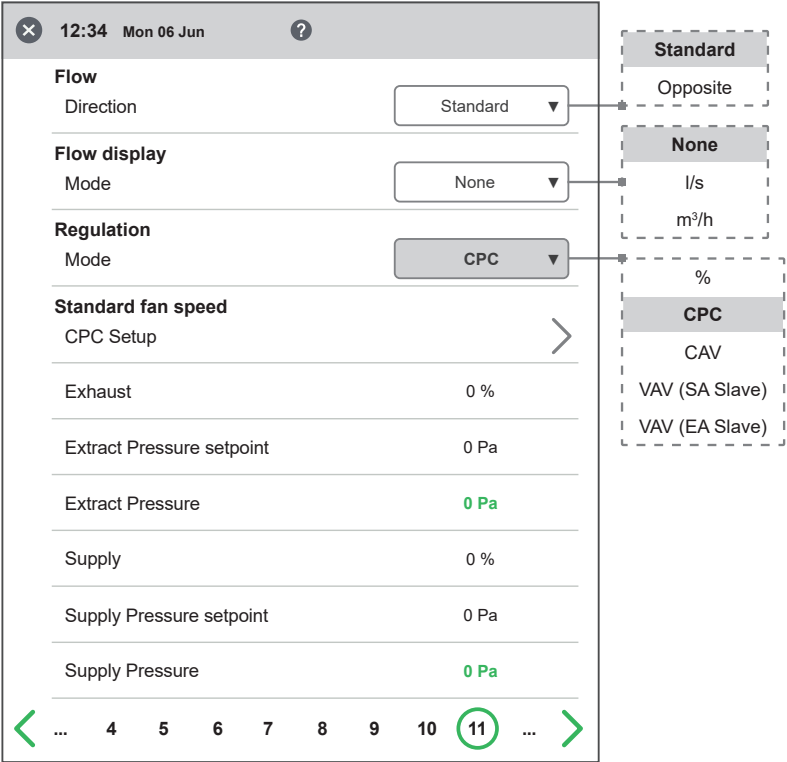

Wizard – 11.2 – Regulation / CPC

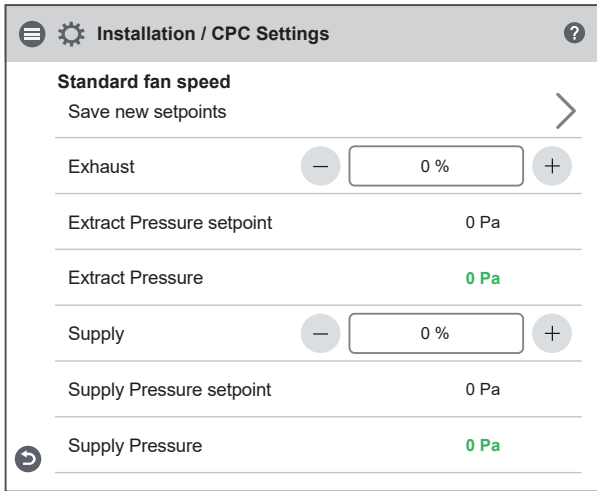

Wizard – 11.2 – Fan regulation "CPC" / Standard fan speed

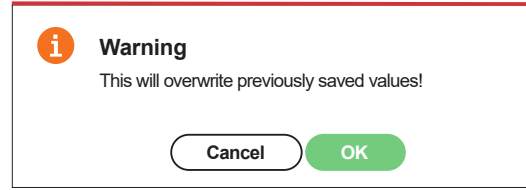

Wizard – 11.2 – Fan regulation "CPC" / Save Pop-up

### 1.11.3 Regulation type "CAV"

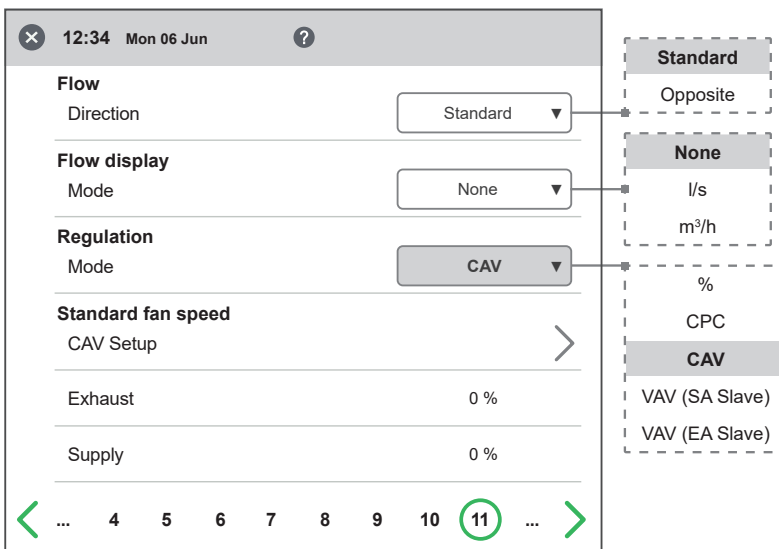

Wizard – 11.3 – Fan regulation "CAV"

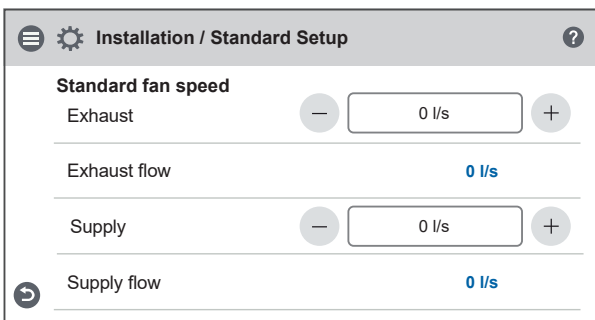

Wizard – 11.3 – Fan regulation "CAV" / Standard fan speed

### 1.11.4 Regulation type "VAV (SA Slave)"

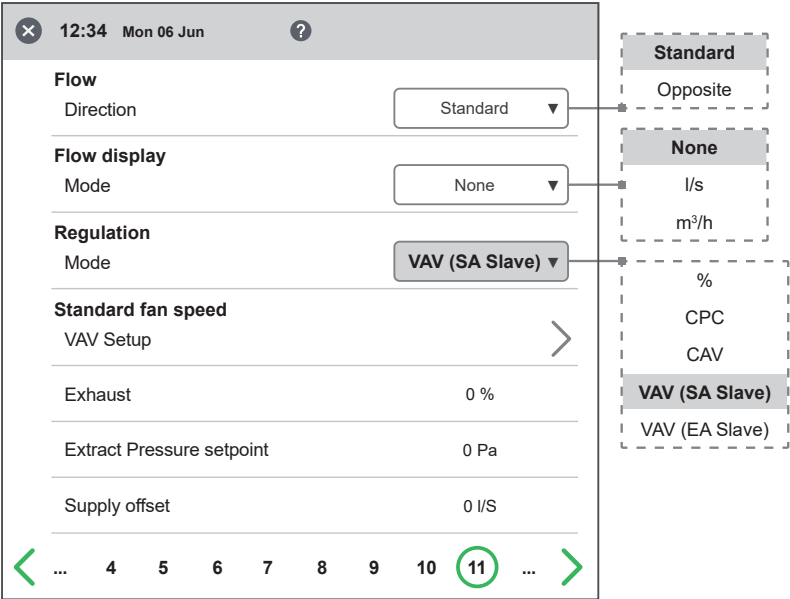

Wizard – 11.4 – Fan regulation "VAV (SA Slave)"

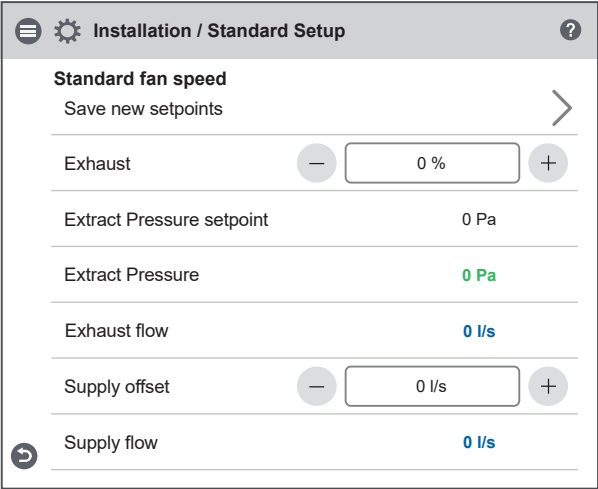

Wizard – 11.4 – Fan regulation "VAV (SA Slave)" / Standard fan speed

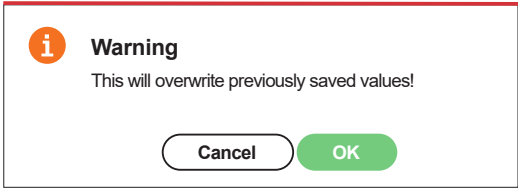

Wizard – 11.4 – Fan regulation "VAV (SA Slave)" / Save Pop-up

### 1.11.5 Regulation type "VAV (EA Slave)"

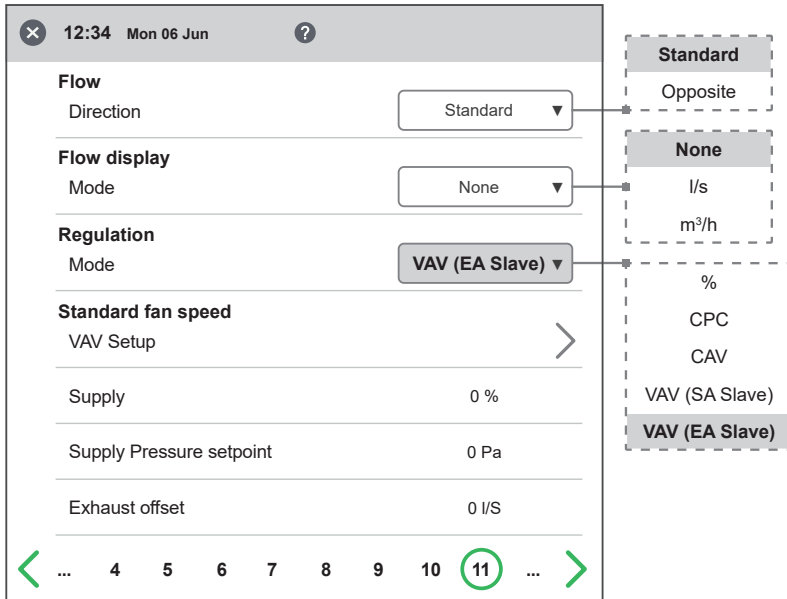

Wizard – 11.5 – Fan regulation "VAV (EA Slave)"

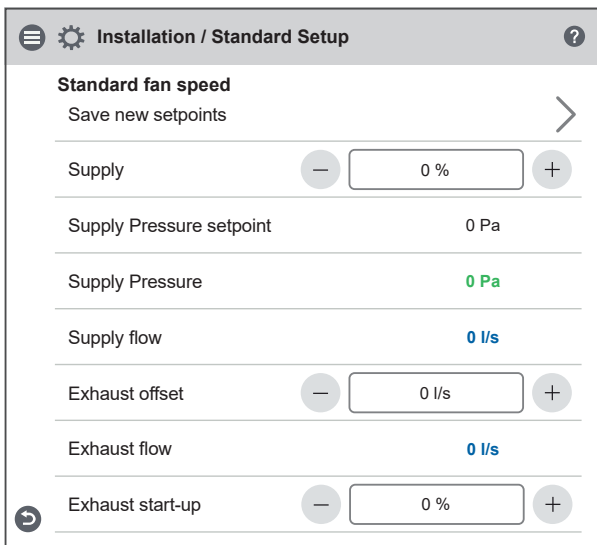

Wizard – 11.5 – Fan regulation "VAV (EA Slave)" / Standard fan speed

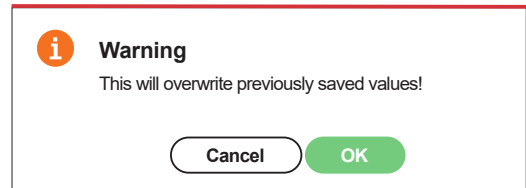

Wizard – 11.5 – Fan regulation "VAV EA Slave)" / Save Pop-up

## 1.12 Step 12 – Flow and regulation

### Min Speed

When entering the setup page, all program parameters that affect the flow of the fans are temporarily deactivated and the program is entering adjustment mode. When leaving the setup page, the unit returns to normal operation.

The exhaust air flow can be adjusted. The supply air flow is calculated automatically based on the ratio in Standard fan speed. In the case of VAV regulation with static offset, the supply and exhaust air flow can be set individually.

#### 1.12.1 Regulation type "Percent (%)" – Min speed

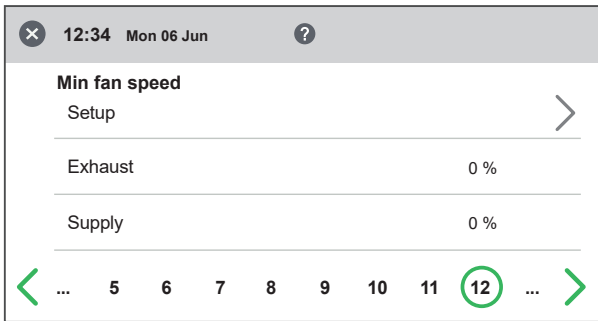

Wizard – 12.1 – Fan regulation " %" / Min fan speed

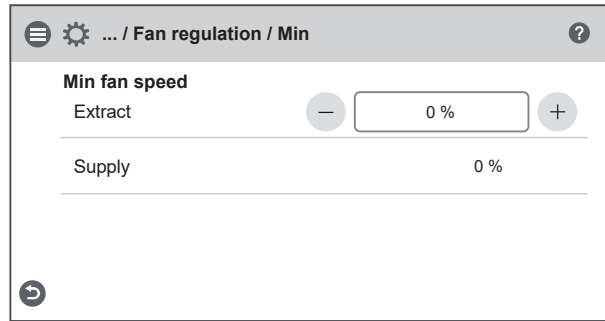

Wizard – 12.1 – Fan regulation " %" / Min fan speed

#### 1.12.2 Regulation type "CPC" – Min speed

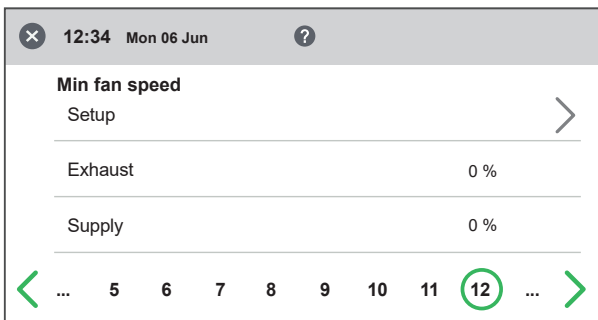

Wizard – 12.2 – Fan regulation "CPC" / Min fan speed

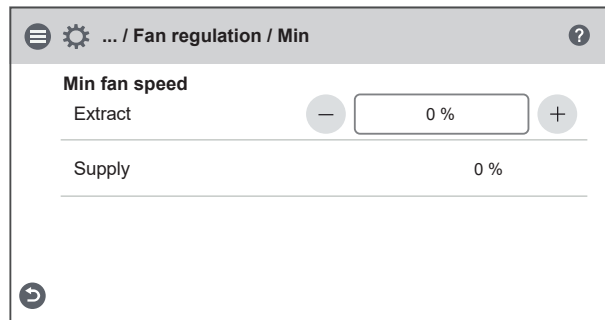

Wizard – 12.2 – Fan regulation "CPC" / Min fan speed

#### 1.12.3 Regulation type "CAV" – Min speed

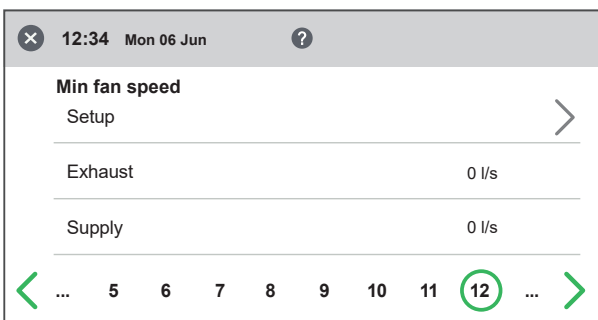

Wizard – 12.2 – Fan regulation "CAV" / Min fan speed

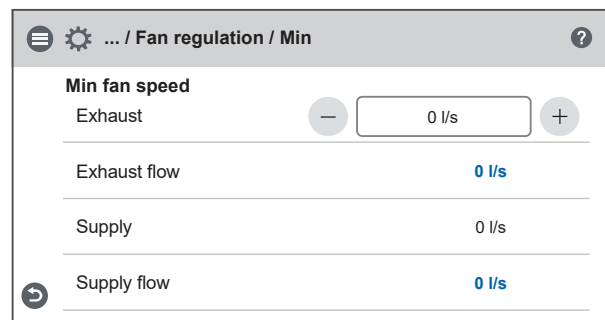

Wizard – 12.2 – Fan regulation "CAV" / Min fan speed

### 1.12.4 Regulation type "VAV (SA Slave)" – Min speed

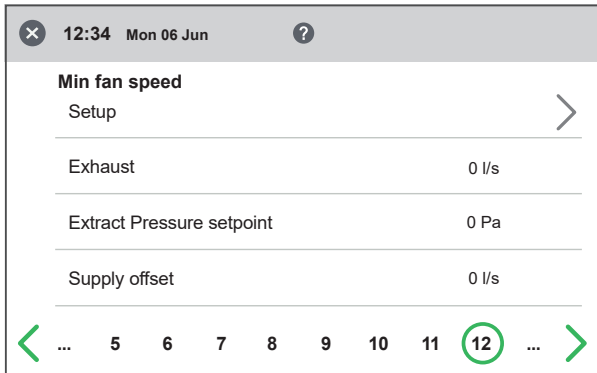

Wizard – 12.4 – Fan regulation "VAV (SA Slave)" / Min fan speed

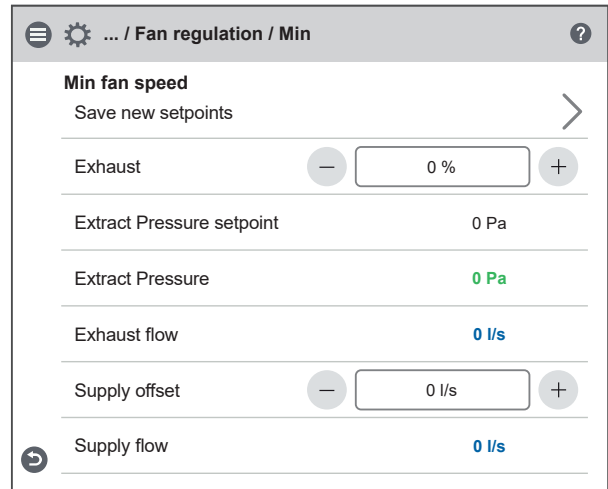

Wizard – 12.4 – Fan regulation "VAV (SA Slave)" / Min fan speed

### 1.12.5 Regulation type "VAV (EA Slave)" – Min speed

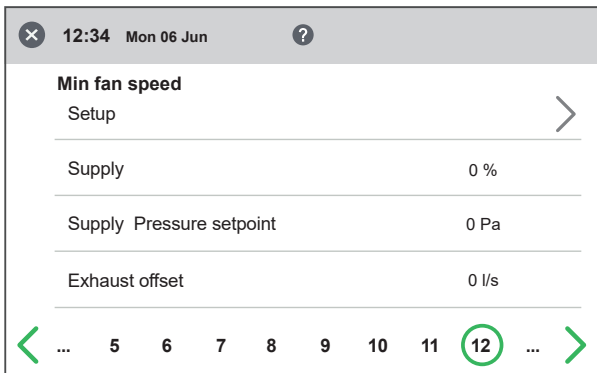

Wizard – 12.5 – Fan regulation "VAV (EA Slave)" / Min fan speed

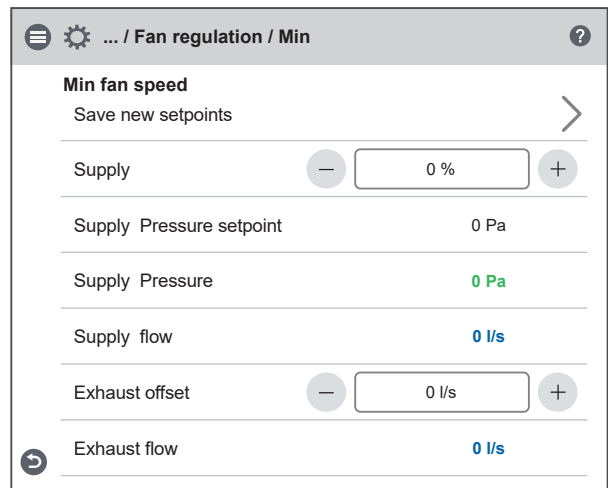

Wizard – 12.5 – Fan regulation "VAV (EA Slave)" / Min fan speed

## 1.13 Step 13 – Flow and regulation

### Max Speed

When entering the setup page, all program parameters that affect the flow of the fans are temporarily deactivated and the program is entering adjustment mode. When leaving the setup page, the unit returns to normal operation.

The exhaust air flow can be adjusted. The supply air flow is calculated automatically based on the ratio in Standard fan speed. In the case of VAV regulation with static offset, the supply and exhaust air flow can be set individually.

#### 1.13.1 Regulation type "Percent (%)" – Max speed

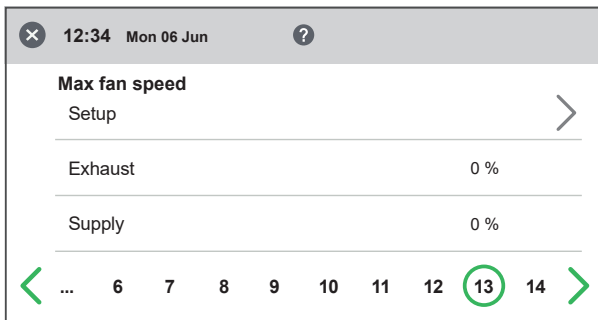

Wizard – 13.1 – Fan regulation " % " / Max fan speed

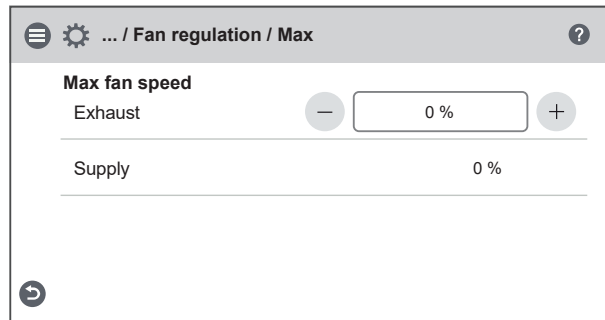

Wizard – 13.1 – Fan regulation " % " / Max fan speed

#### 1.13.2 Regulation type "CPC" – Max speed

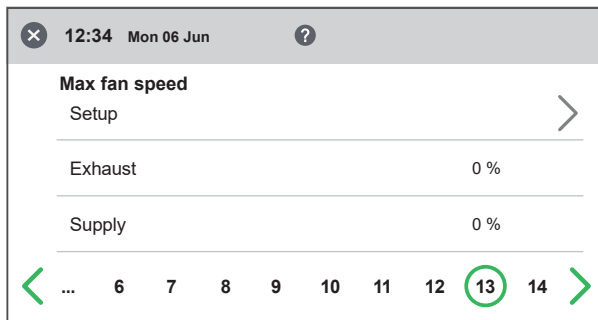

Wizard – 13.2 – Fan regulation "CPC" / Max fan speed

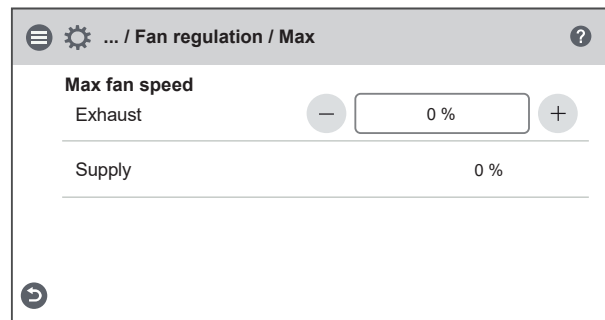

Wizard – 13.2 – Fan regulation "CPC" / Max fan speed

#### 1.13.3 Regulation type "CAV" – Max speed

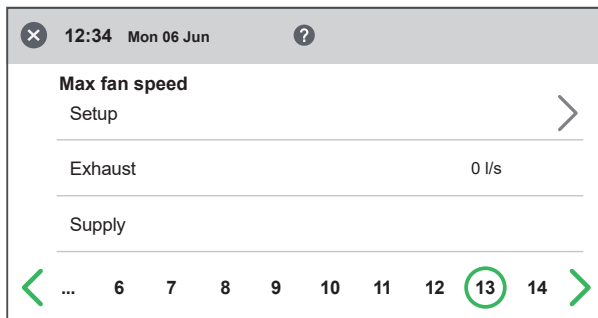

Wizard – 13.2 – Fan regulation "CAV" / Max fan speed

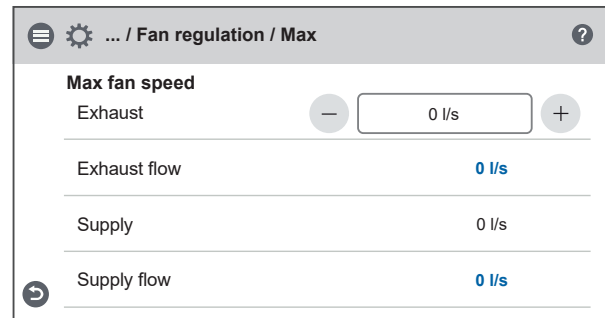

Wizard – 13.2 – Fan regulation "CAV" / Max fan speed

### 1.13.4 Regulation type "VAV (SA Slave)" – Max speed

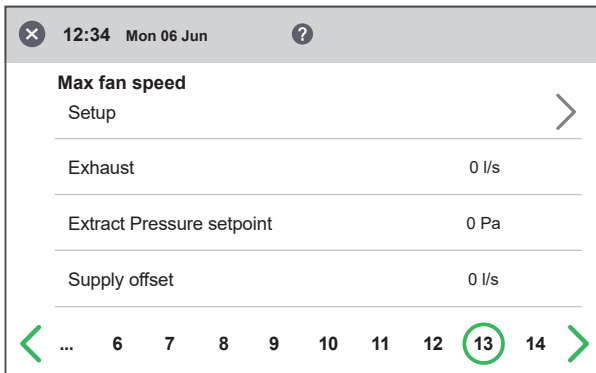

Wizard – 13.4 – Fan regulation "VAV (SA Slave)" / Max fan speed

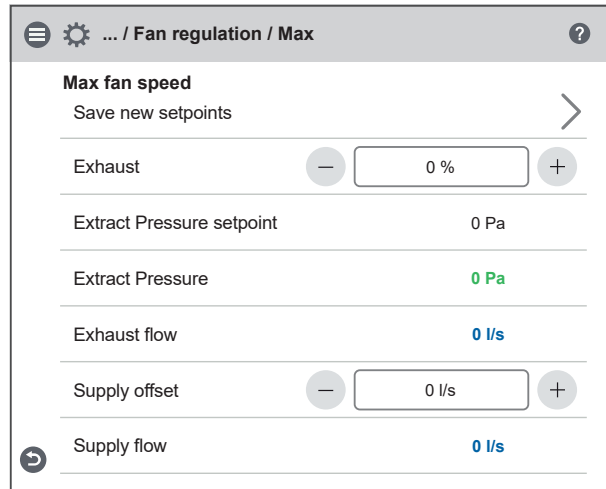

Wizard – 13.4 – Fan regulation "VAV (SA Slave)" / Max fan speed

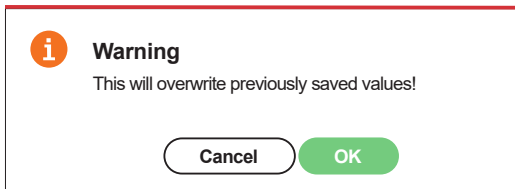

Wizard – 13.4 – Fan regulation "VAV (SA Slave)" / Save Pop-up

### 1.13.5 Regulation type "VAV (EA Slave)" – Max speed

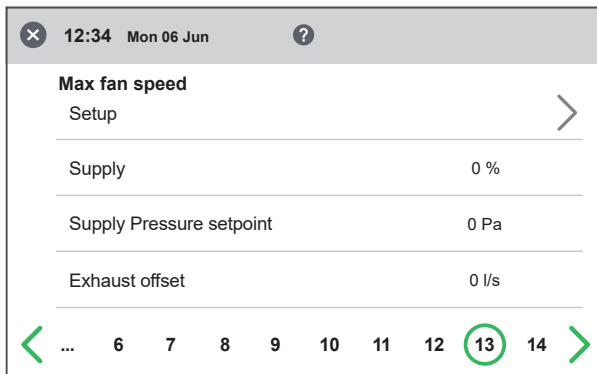

Wizard – 13.5 – Fan regulation "VAV (EA Slave)" / Max fan speed

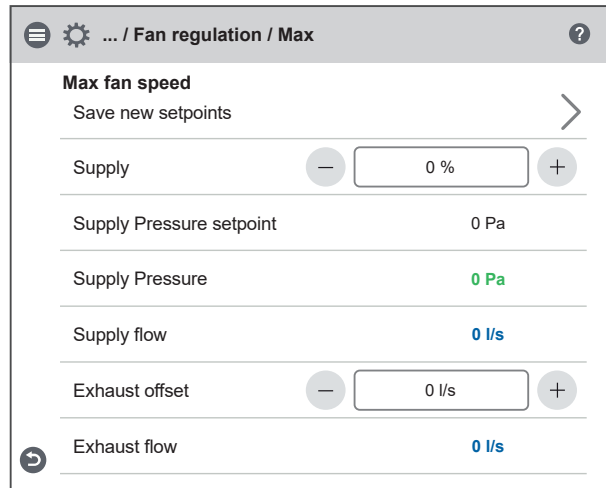

Wizard – 13.5 – Fan regulation "VAV (EA Slave)" / Max fan speed

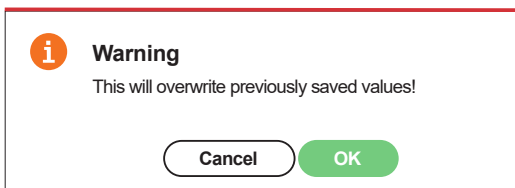

Wizard – 13.5 – Fan regulation "VAV (EA Slave)" / Save Pop-up

## 1.14 Save settings

Press Ja to save all settings made in the wizard.  
Previously set values will be overwritten.

Press Cancel to discard all settings made in the wizard  
and return to the previous menu.

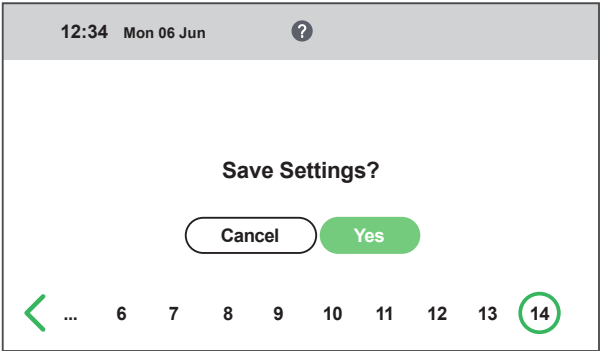

Wizard – 13.5 – Save settings

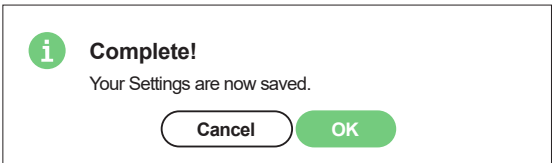

Wizard – 13.5 – Save settings / OK

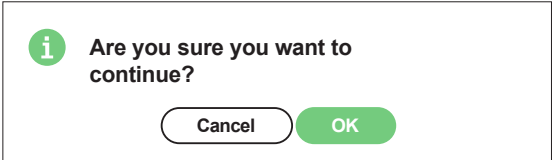

Wizard – 13.5 – Save settings / Cancel

# Appendix 2 IQC Menu structure

## 2.1 Startup and main menu

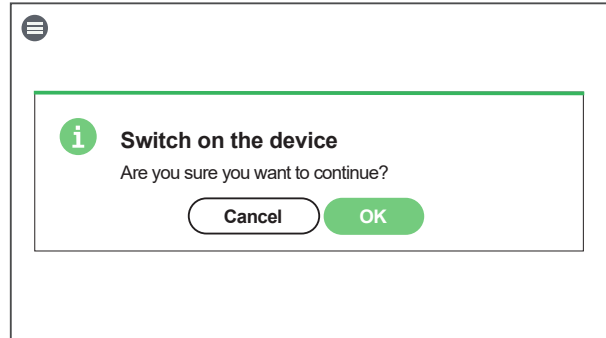

Startup

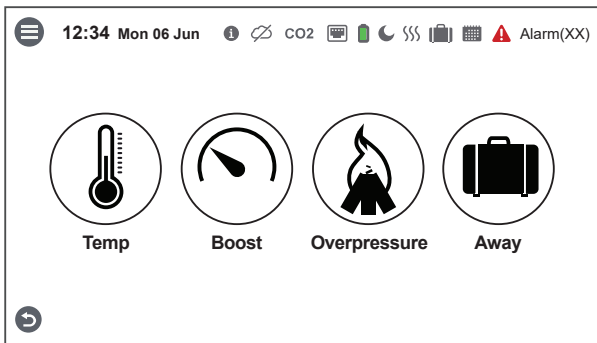

Home screen

### 2.1.1 Main menu

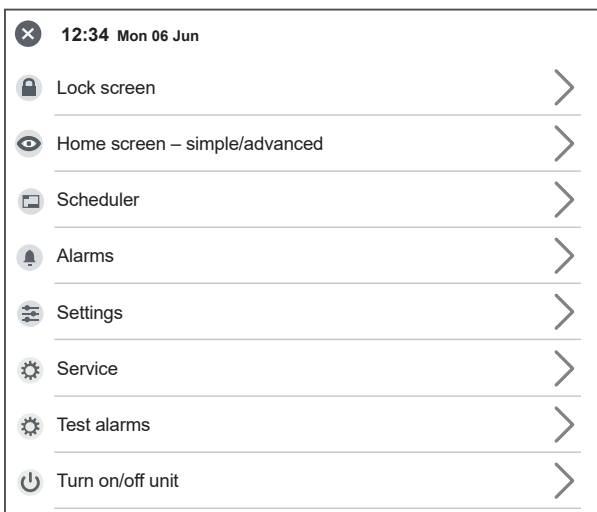

Main menu

### 2.2 Lock screen

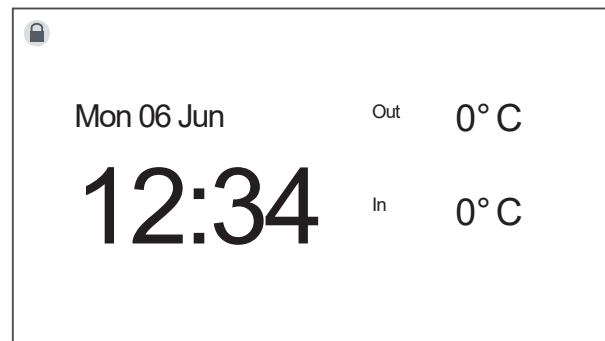

Lock screen

## 2.3 Home screen

### 2.3.1 Home screen simple

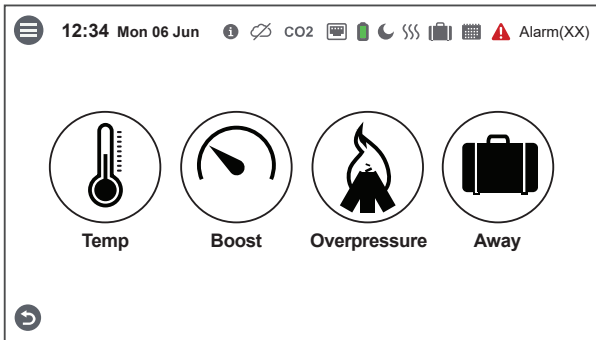

Home screen simple

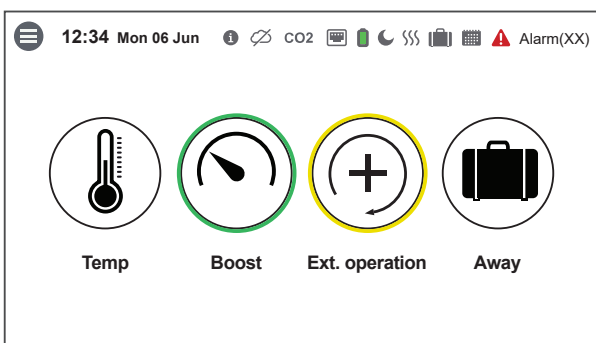

Home screen simple with activated boost and extended operation

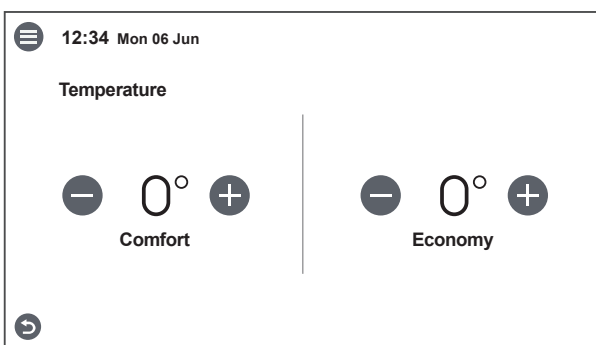

Temperature

### 2.3.2 Home screen advanced

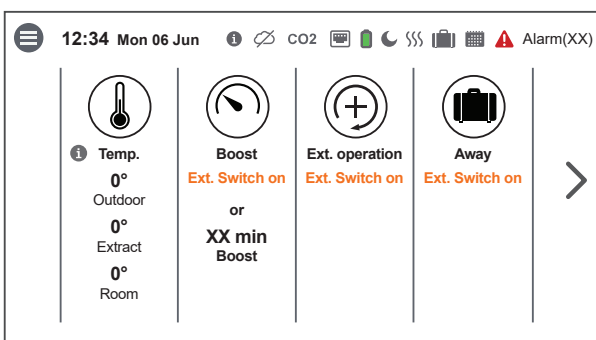

Home screen advanced

#### Temperature

Presents temperatures in the unit. Tap on the symbol to open the temperature setpoint menu. Tap on temperatures opens detailed temperature window. Only in home screen advanced.

#### Boost

Displays the status of the function. Tap on the symbol to start the function. A green ring confirms that function has started and are active. The function is automatically deactivated after the set time has expired or by tapping on the symbol again.

#### Overpressure

Displays the status of the function. Tap on the symbol to start the function. A green ring confirms that the function has started and are active. The function is automatically deactivated after the set time has expired or by tapping on the symbol again.

#### Extended operation

Possibility to control the unit to Extended operation according to a specific time in addition to the regular operating scheme. A yellow ring confirms that the function has started and are active, but does not run due to priority order.

#### Away mode

Displays the status of the function. Tap on symbol to start function. A green ring confirms that function is started and active. The function remains active until it is deactivated by tapping on the symbol again. The Boost- or Overpressure functions will have priority over the Away mode. A Yellow ring confirms that the function is activated automatically immediately after Overpressure/Boost is deactivated after a set time or by a press on its symbol.

#### Fans

Shows the status of the fans. Fan signal is presented in %. Pressure and flow values can also be displayed (requires accessories).

#### Air quality

Displays the status of air quality. Presents measurement values from active sensors. Measured value flashing indicates active RH/CO2/VOC Boost.

#### Recovery

Displays the status of heat recovery or cooling recovery. Indicates the type of recovery that is active and current temperature efficiency.

#### Filter Status

Shows the status of filters according to the selected type of filter monitoring.

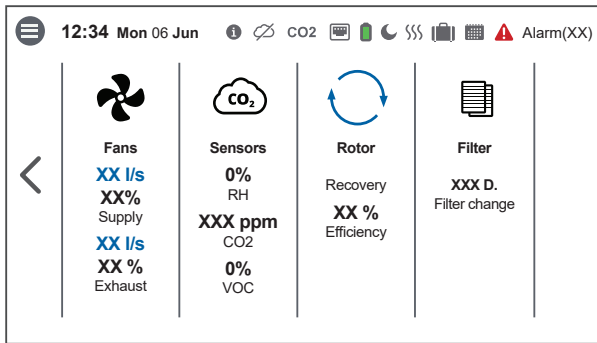

Home screen advanced

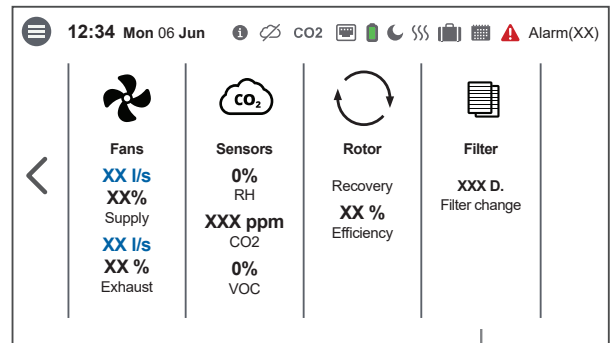

Home screen advanced

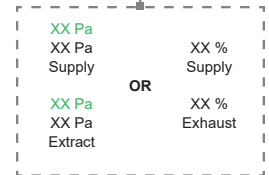

## 2.4 Scheduler – “7.3 Scheduler” page 37

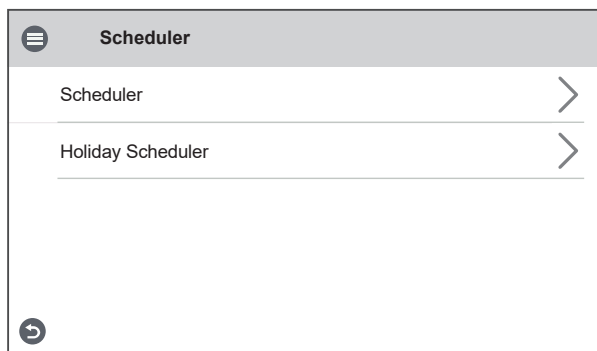

Scheduler menu

### Program toggle

Enables or Disables Scheduler.

### Program week

5 programs with individual toggle to activate/deactivate specific program. Pressing the arrow opens editing of the program's active days, start and end times and the desired fan speed. If eco. temperature setpoint is used, it's also possible to select between Comfort or Economy setpoint. Programs with lower index (program number) have priority.

### Program toggle

Enables or disables Holiday scheduler.

### Program holiday

10 programs with individual toggle to activate/deactivate specific program. Pressing the arrow opens editing of the program's start- and end date/end time and the desired fan speed.

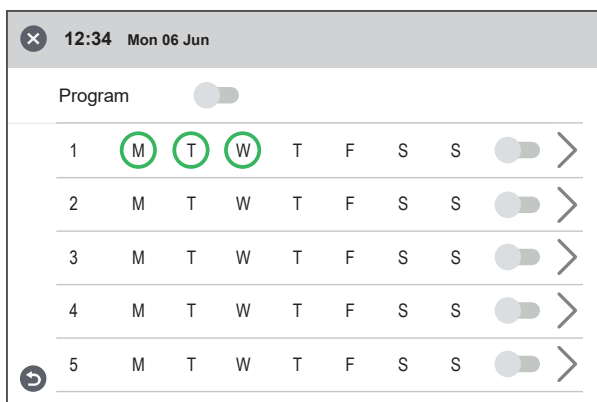

Week scheduler

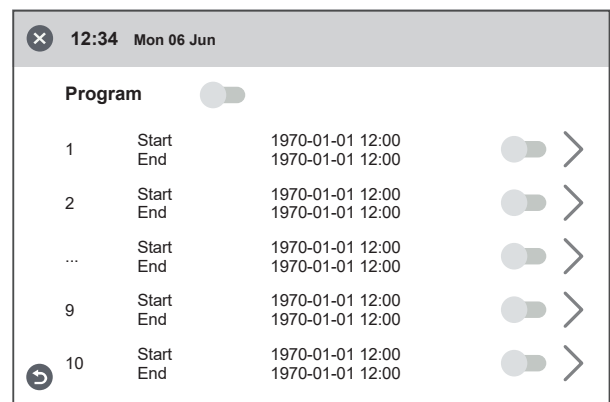

Holiday scheduler

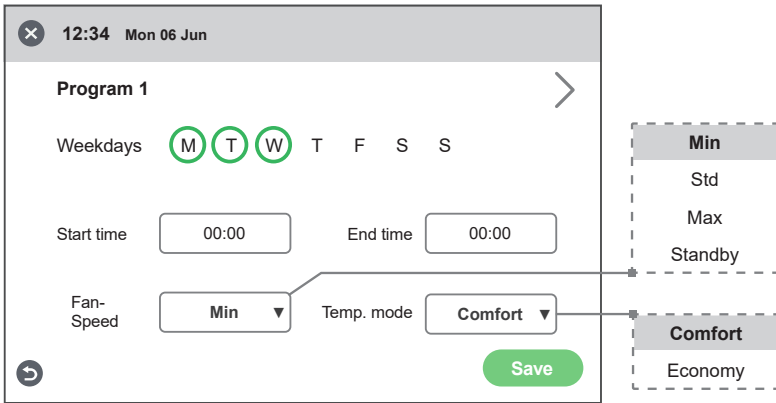

Scheduler – program menu

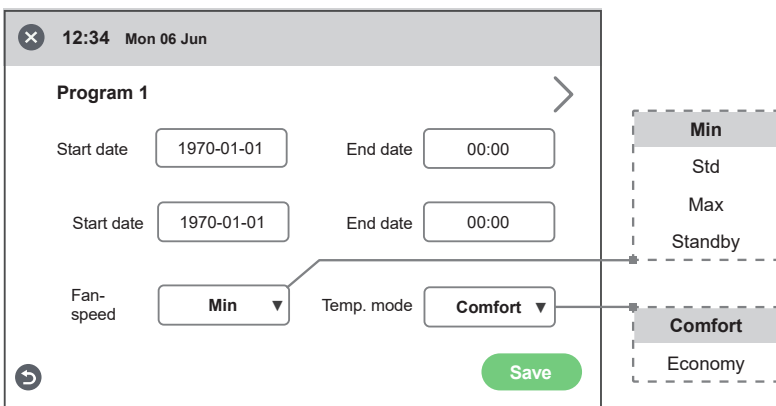

Holiday scheduler – program menu

## 2.5 Alarms – “7.5 Alarms and limits” page 41

### List of active alarms in the device

Date and time indicate when the alarms occurred. For a more detailed description of the alarm, tap on specific alarm row.

Red text represents A-alarm and yellow text B-alarm.

### Alarm history

List of old alarms in the unit.

The date and time indicate when the alarms occurred and when it was reset. For a more detailed description of the alarm, tap on specific alarm row.

Red text represents A-alarm and yellow text B-alarm.

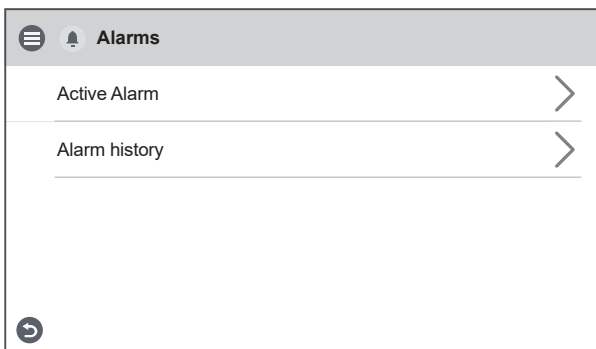

Alarm menu

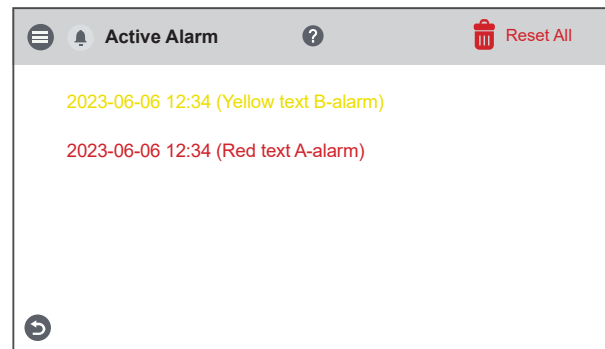

Active alarm

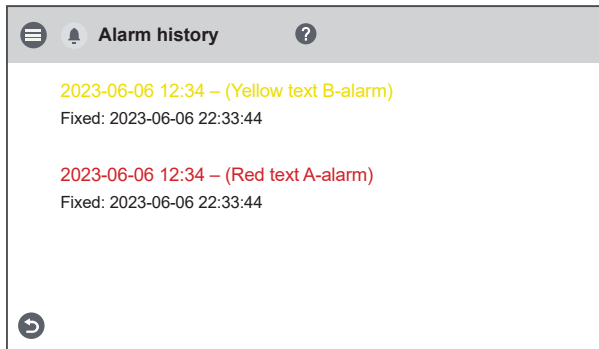

Alarm history

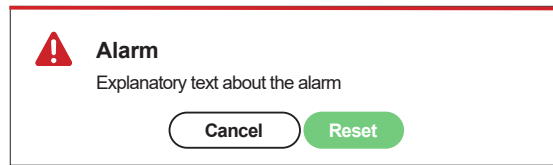

Alarm reset

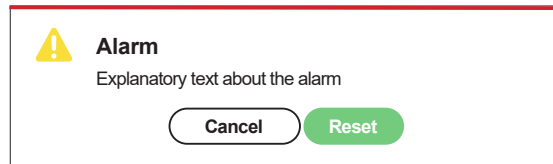

## 2.6 Settings

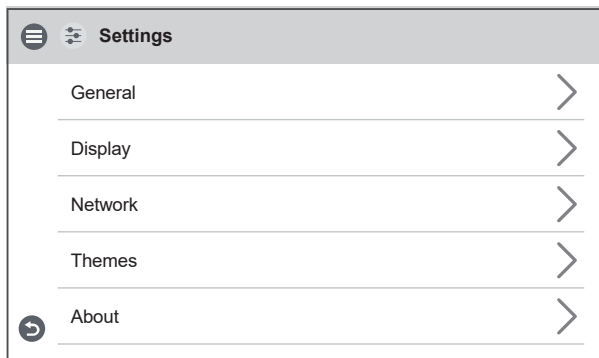

Settings menu

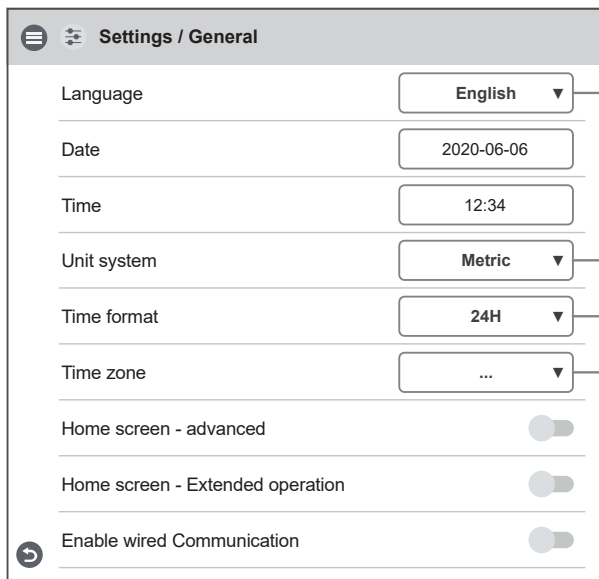

Settings general

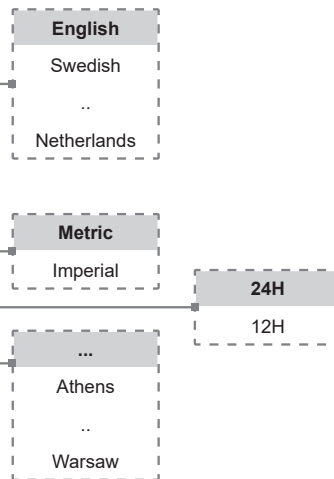

### Home screen – advanced

The toggle activates the home screen advanced.

### Home screen – Extended Operation

The toggle switches between Ext, operation and Boost on the home screen advanced.

### Enable wired Communication

The toggle activates wired communication thru the Active Dock Holder.

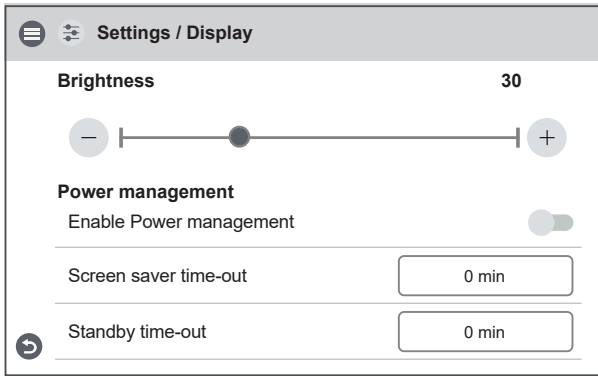

Settings display

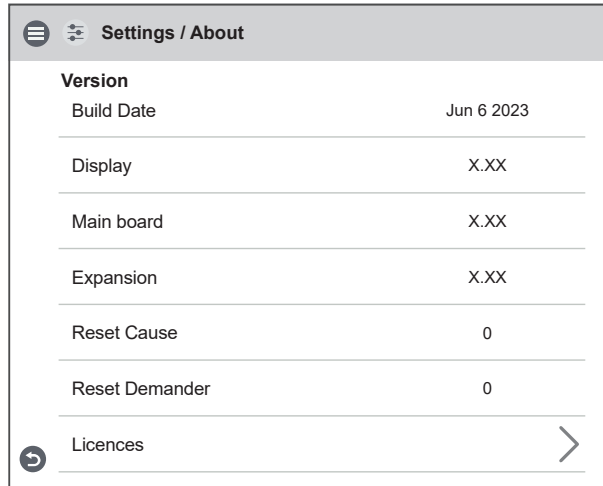

Settings about

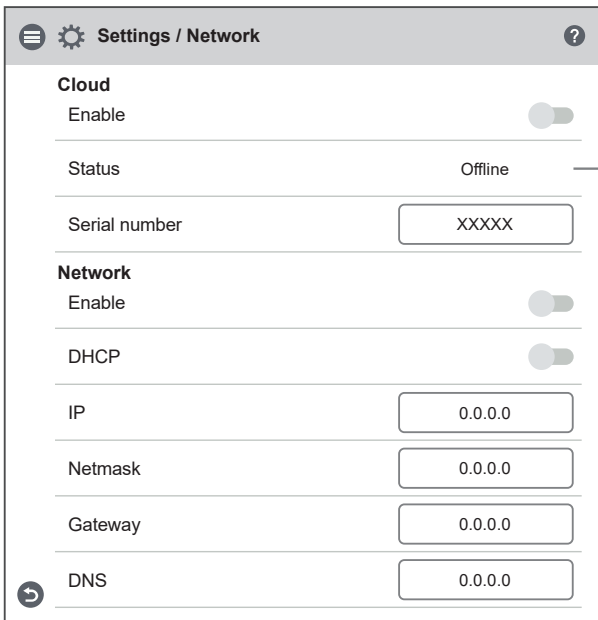

Settings network

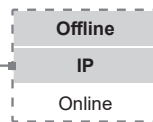

**Cloud**

**Enable**  
Used for activating / deactivating connection to Cloud service.

**Pairing**  
Press pairing to be assigned a pairing key for connection to the app.

**Reset pairing**  
Removes all paired devices.

**Status:** Indicates the status of connection to Cloud service.

**Serial number:** ID for Cloud service.

**Network**

**DHCP**  
Enable to be automatically assigned an IP address and DNS server dynamically from the network.

If a static IP address is to be used, data for IP, Netmask, Gateway and DNS is entered manually.

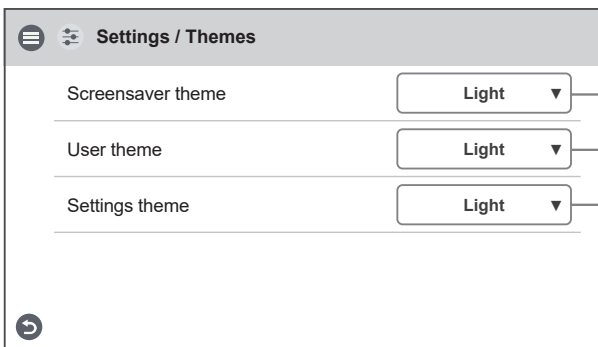

Settings themes



## 2.7 Service user special settings – code 9900

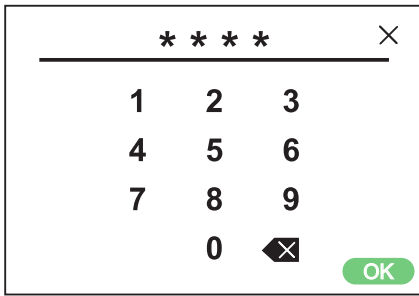

Service 9900

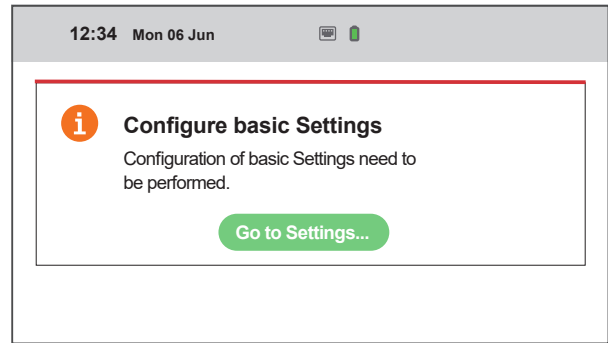

Service 9900 – Pop-up, will only appear when settings for rotor size and/or temperature sensor type is necessary.

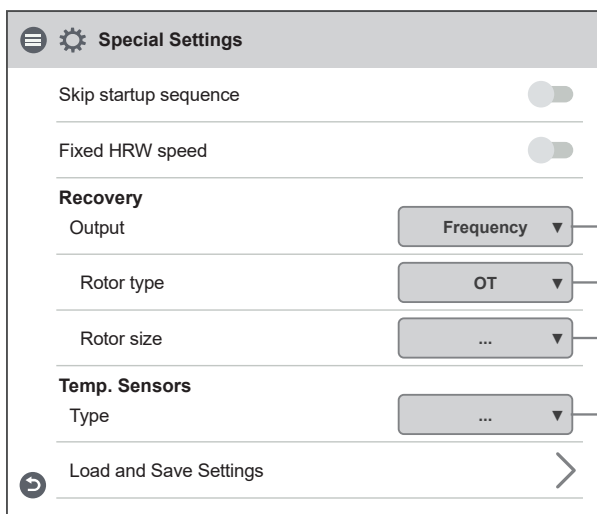

Service 9900 – Special Settings

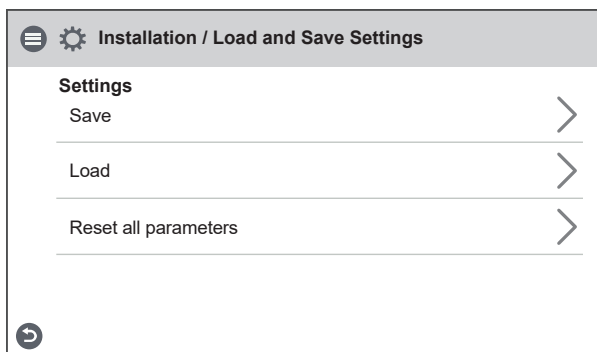
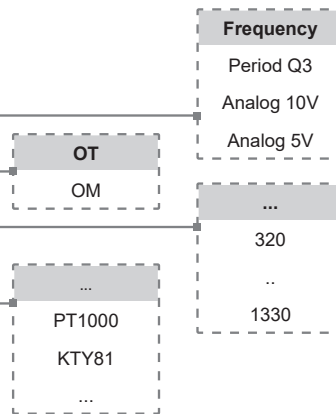

Service 9900 - Load and save

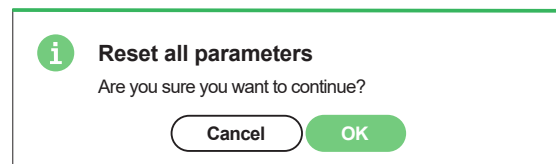
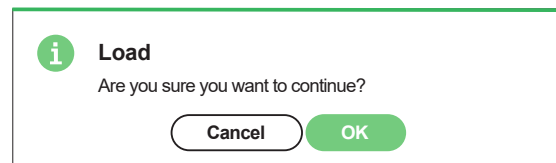
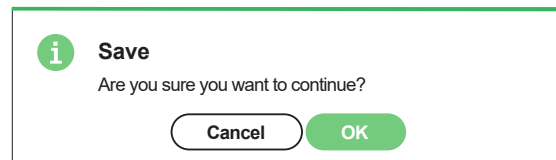

Service 9900 - Load and save pop-up. Alle settings made in the display/app are reset to factory settings.

## 2.8 Service user – code 1199

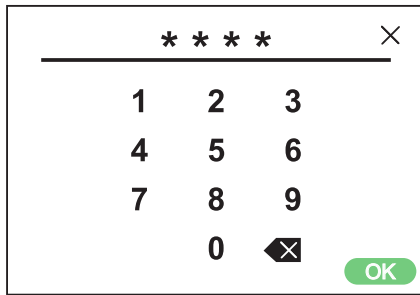

Service input code 1199

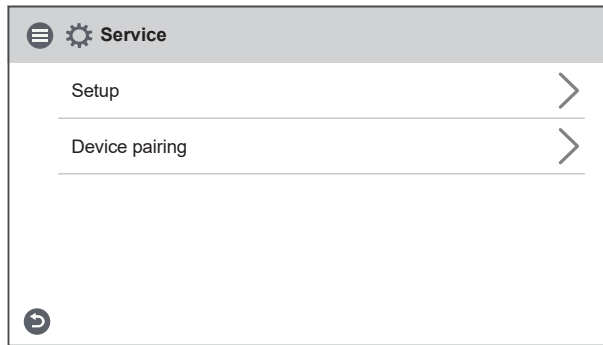

Service 1199

### 2.8.1 Service – setup

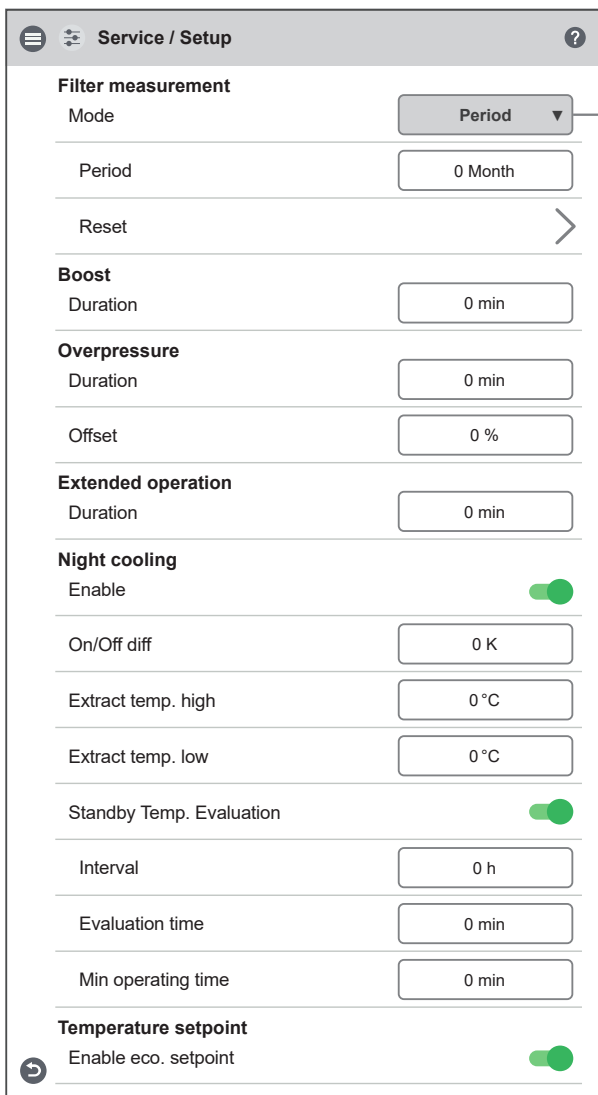

Service 1199 – Setup – period

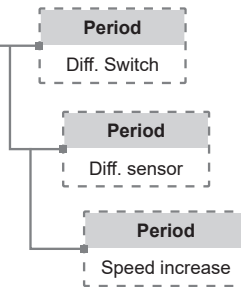

#### Filter Measurement

Type of filter control.

- **Period:** Selected by default. Gives an alarm when the service period has expired. **[Reset]** starts new service period.
- **Diff. switch:** Scheduled filter measurement at selected day and time (requires accessories).
- **Diff. sensor:** Scheduled filter measurement at selected day and time. Compare measured value against set final Pressure drop (requires accessories).
- **Speed increase:** In CPC control of fans, the output signal of the fans can be used as a reference when measuring filter clogging. The limit value for filter alarms is the saved reference value of the fans increased by the set value for speed increase. Speed increase means keeping a constant Pressure in the duct by increasing the fans' output signal to compensate for clogged filters (requires accessories).

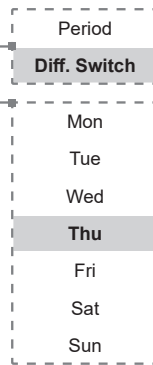
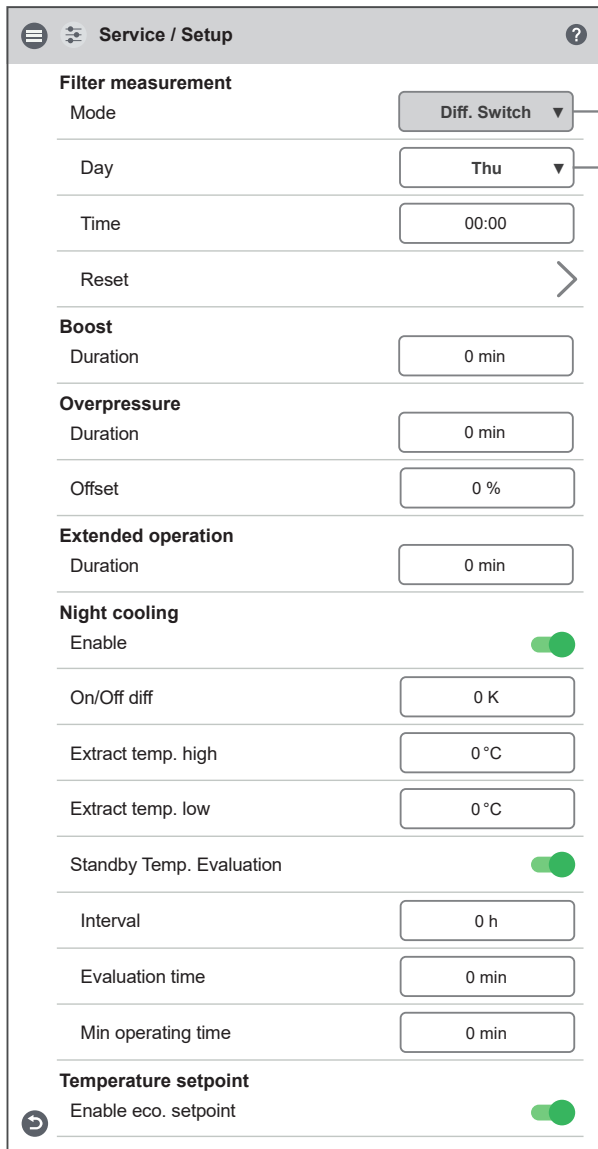

Service 1199 – Setup – diff switch

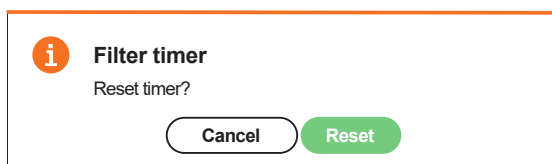

Service 1199 – Setup – Reset

**Boost**

Setting duration. 10-240 min.

**Overpressure**

Setting duration. 5-60 min.

Offset of supply air fan. Can be set min: 5% to max: the diff. between Max and Min speed.

**Extended operation**

- Pulse: Fans operate at normal speed. Setting duration. 10-240 min.
- Switch: Fans operate in normal speed as long as the input is kept active.

The function can be activated / deactivated, even when the time period has not expired.

**Night cooling**

Temperature controlled boost.

- The temperature criterion In/Out diff. must be true together with Exhaust air High in order for function to be activated.
- The function remains active until Exhaust Air Low is met or In/Out diff. is no longer true.

**Standby Temp. Evaluation**

- Interval: Time between evaluations.
- Evaluation time: Runtime for updating temperatures.
- Minimum operating time: If there is a need for running night cooling, the minimum operating time is set before the plant will go back to hibernation.

**Temperature setpoint**

Extra economy temperature setpoint can be activated, which allows for two temperature setpoints in the scheduler.

☰ Service / Setup
?

**Filter measurement**

Mode Diff. sensor ▼

---

Day Thu ▼

---

Time 00:00

---

Extract 0 Pa

---

Limit 0 Pa

---

Supply 0 Pa

---

Limit 0 Pa

**Boost**

Duration 0 min

---

**Overpressure**

Duration 0 min

---

Offset 0 %

---

**Extended operation**

Duration 0 min

---

**Night cooling**

Enable

---

On/Off diff 0 K

---

Extract temp. high 0 °C

---

Extract temp. low 0 °C

---

Standby Temp. Evaluation

---

Interval 0 h

---

Evaluation time 0 min

---

Min operating time 0 min

---

**Temperature setpoint**

Enable eco. setpoint

Period

Diff. sensor

---

Mon

Tue

Wed

Thu

Fri

Sat

Sun

Service 1199 – Setup – diff sensor

The screenshot shows a 'Service / Setup' menu with the following sections and settings:

- Filter measurement**
  - Mode: Speed increase (dropdown menu, highlighted by a callout box labeled 'Period' and 'Speed increase')
  - Speed increase: 0 %
- Boost**
  - Duration: 0 min
- Overpressure**
  - Duration: 0 min
  - Offset: 0 %
- Extended operation**
  - Duration: 0 min
- Night cooling**
  - Enable:
  - On/Off diff: 0 K
  - Extract temp. high: 0 °C
  - Extract temp. low: 0 °C
  - Standby Temp. Evaluation:
  - Interval: 0 h
  - Evaluation time: 0 min
  - Min operating time: 0 min
- Temperature setpoint**
  - Enable eco. setpoint:

Service 1199 – Setup – speed increase

## 2.8.2 Service – Device pairing

Service 1199 – Setup – Device pairing

Service 1199 – Setup - pop-up

### Search for device (40s.)

Sets IQC-Display in search mode. Searching for device for 40 sec.

For the unit to be found, turn the power to the HERU unit off and then on again.

After 40 seconds, if no unit is detected, the IQC-Display returns to initial state.

### Unit number

ID number on the IQC-Display allows to have more displays connected to the same HERU unit.

One IQC-Display must always be master. ID 1 is master. ID 2 is slave. No IQC-Display may have the same ID.

When changing the display ID number, the unit is automatically restarted.

### Clear pairing

Removes previous connections made to the HERU unit.

### Display unit restart

Forces restart of display unit.

## 2.9 Service installation – code 1991

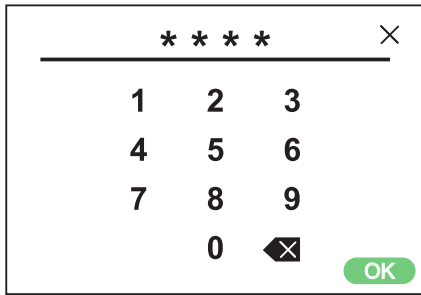

Service 1991

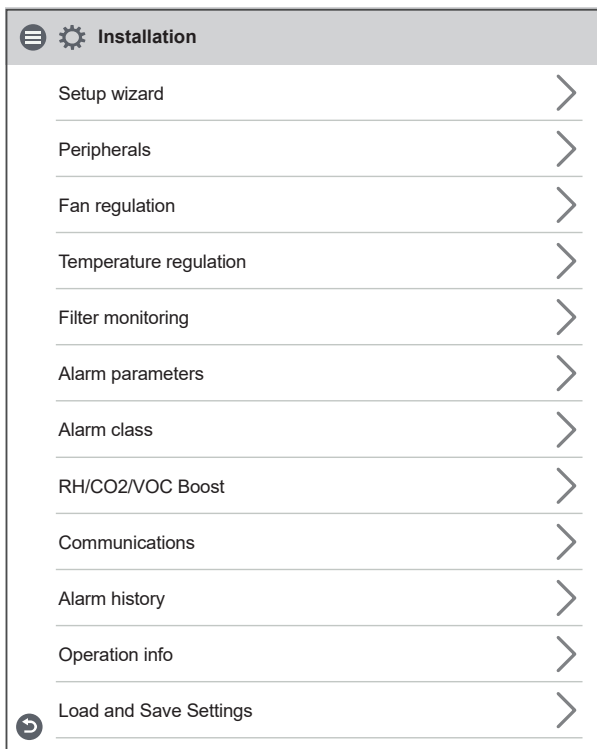

“Appendix 1 IQC – Installation Wizard” page 51

Chapter “2.9.1 Installation – Peripherals” page 89

Chapter “2.9.2 Installation – Fan regulation” page 94

Chapter “2.9.3 Installation – Temperature regulation” page 104

Chapter “2.9.4 Installation – Filter monitoring” page 108

Chapter “2.9.5 Installation – Alarm parameters” page 110

Chapter “2.9.6 Installation – Alarm class” page 113

Chapter “2.9.7 Installation – RH/CO2/VOC Boost” page 114

Chapter “2.9.8 Installation – Communications” page 114

Chapter “2.9.9 Installation – Alarm history” page 115

Chapter “2.9.10 Installation – Operation info” page 116

Chapter “2.9.11 Installation – Load & Save Settings” page 117

Service 1991 – Installation

## 2.9.1 Installation – Peripherals

The screenshot shows the 'Installation / Peripherals' menu with the following settings and their corresponding options:

- Dampers**: Opening time: 0 s
- Afterheater**: Type: Water
- Cooling**: Type: Water
- Preheater**: Type: Electric
- Switch input signal type**: Boost: Pulse, Away: Pulse, Extended operation: Pulse
- Switch input contact func.**: Fire alarm: NO, Heater pump alarm: NO, Cooler alarm: NO, Boost: NO, Overpressure: NO, Extended operation: NO, Away: NO, Filter: NO, Emergency / Service Switch: NO, Sum./ Win. Switch: NO
- Emergency / Service Switch**: Function: None
- Setpoint adjustment**: Enable: (checked), Limit: ± 0 K

The options shown in the diagram are:

- None, Water, Electric, PAC-IF013
- None, Water, PAC-IF013
- None, Electric
- Pulse, Switch
- NO\*, NC\*
- None, Emergency stop, Service Switch

Service 1991 – Installation / Peripherals

### “6 Peripherals” page 27

#### Damper

Opening time setting for dampers. Acts as start-up delay of the extract air fan to allow time for dampers to open.

For opening times, see separate data sheet for damper motor.

#### After Heater

Selection of which type of afterheater installed.

When selecting electric heater, after-cooling function can also be used.

#### Cooling

Selection of which type of cooling device that is installed.

#### Pre-heater

Selection of which type of preheater that is installed. Setpoint setting is done under menu Alarm parameters.

#### External inputs – Signal type

Choice of signal type from external equipment.

“Pulse”

is used for instant contact function.

“Switch”

is used for sustained contact function.

#### External inputs Contact function

Choice of contact function from external equipment.

NO: Normally Open

NC: Normally Closed.

#### Emergency Stop Service Switch

Possibility to use Emergency Stop / Service Switch via input D6. If Expansion board is activated, the function is activated via input DI9.

#### Setpoint adjustment comfort temp (only with expansion board installed and activated)

Possibility to shift the temperature setpoint within the selected range.

- Limit: Setting of temperature range to be applied to external input. Temperature factor is added to the temperature setpoint.

\* The dynamic menus are same for both NO and NC.

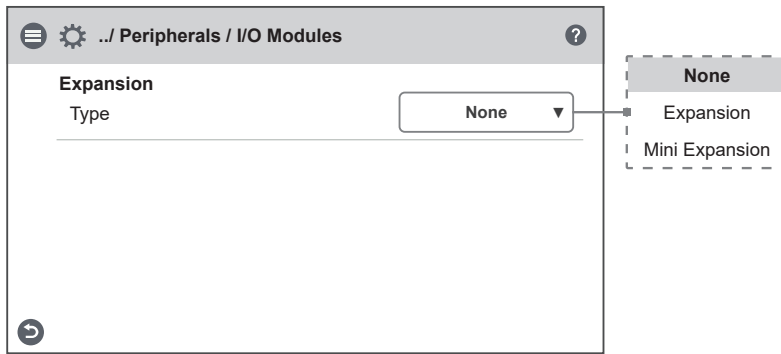

Service 1991 – Installation / Peripherals / I/O modules

**I/O Module type**

Select the type of expansion module that is connected to the unit.

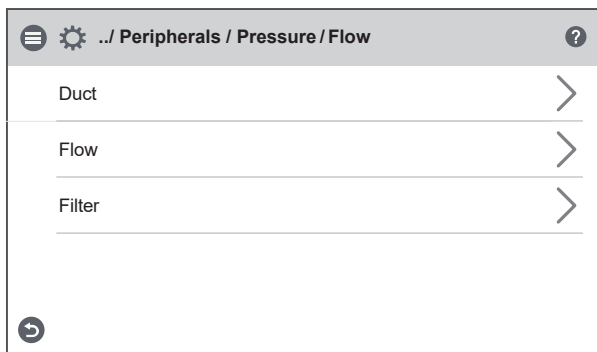

Service 1991 – Installation / Peripherals / Pressure/Flow

**Settings for duct Pressure measurement with Pressure sensor**

**Type**

Selection of signal type from sensor. Can be set to 0-10V or Modbus depending on peripherals.

If the sensor type is set to 0-10V, the Pressure range must be selected according to what is set in the Pressure sensor.

If the sensor type is set to Modbus, the Pressure range is set automatically.

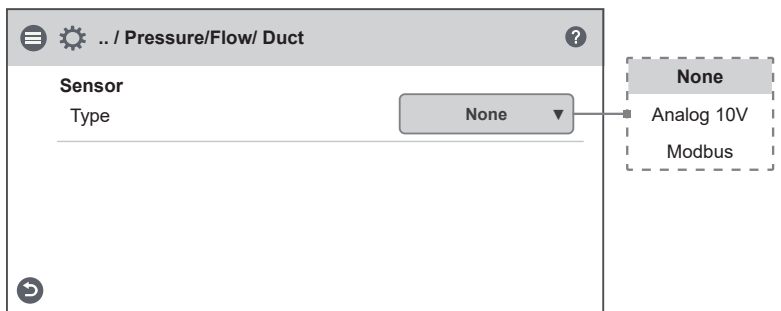

Service 1991 – Installation / Peripherals / Pressure/Flow / Duct

**Modell**

Choice of supported Modell.

**Function**

Selection of the Pressure sensor operating function. For duct Pressure sensor, individual is always selected.

**Info**

Real-time information and status from Pressure sensor.

The Pressure values GP1 and GP2 are direct actual values from the Pressure sensor.

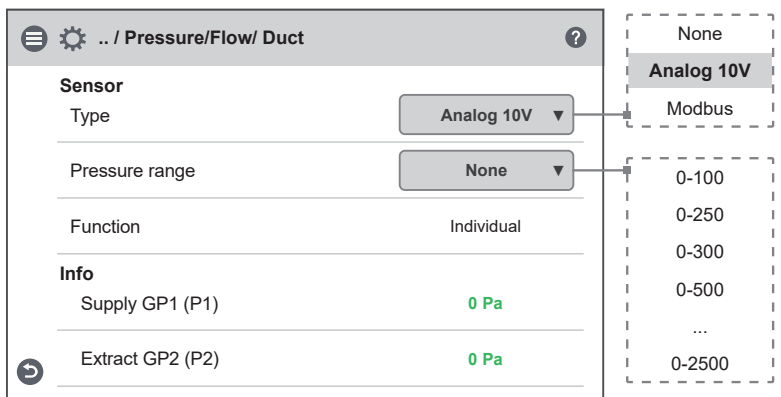

Service 1991 – Installation / Peripherals / Pressure/Flow / Duct – Analog 10V

**Zero-point calibration**

When the sensor type is selected to Modbus, you can do Zero-point calibration of the Pressure sensor via display. Alle connected hoses must be disconnected when performing calibration.

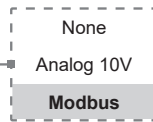
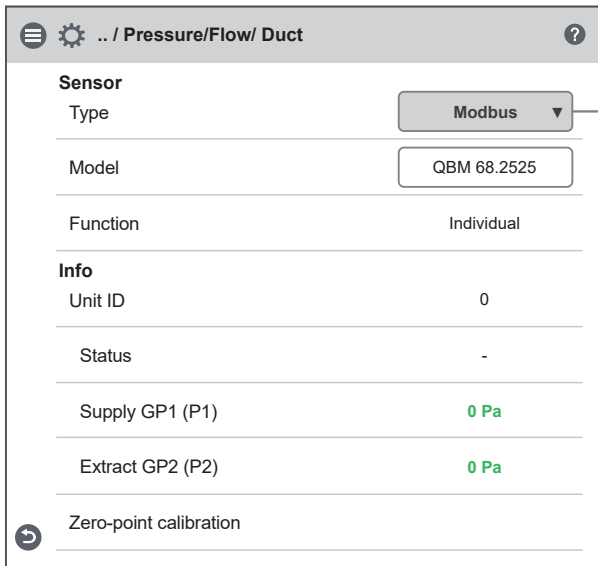

Service 1991 – Installation / Peripherals / Pressure/Flow / Duct – Modbus

### Settings for flow measurement with Pressure sensor

#### Type

Selection of signal type from sensor. Can be set to 0-10V or Modbus depending on peripherals.

If the sensor type is set to 0-10V, the Pressure range must be selected according to what is set in the Pressure sensor.

If the sensor type is set to Modbus, the Pressure range is set automatically.

#### Modell

Choice of supported Modell.

#### Function

Selection of the Pressure sensor operating function. Individual is used when the Pressure sensor is externally mounted outside the unit. Combined is used when it is internally mounted in the unit.

#### K factor

The unique coefficient of the fan mounted in the unit.

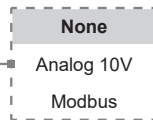
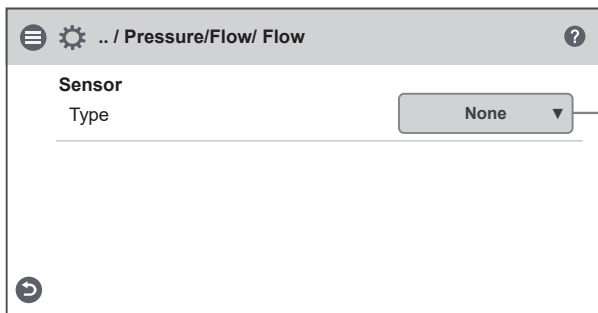

Service 1991 – Installation / Peripherals / Pressure/Flow / Flow

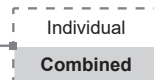
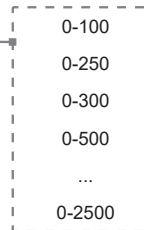
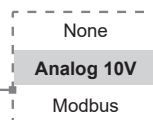
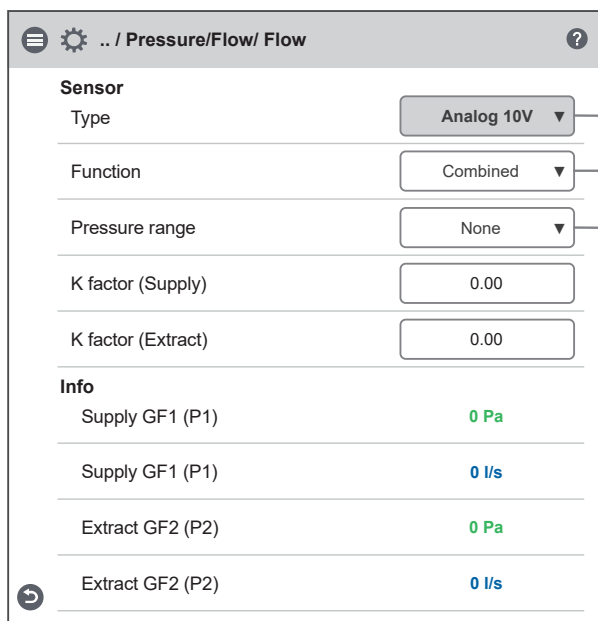

Service 1991 – Installation / Peripherals / Pressure/Flow / Flow – Analog 10V

☰ ⚙️ .. / Pressure/Flow/ Flow
?

<b>Sensor</b>	
Type	Modbus ▼
Model	QBM 68.2525 ▼
Function	Combined ▼
K factor (Supply)	0.00
K factor (Extract)	0.00
<b>Info</b>	
Unit ID	0
Status	-
Extract GF1 (P1)	0 Pa
Supply GF1 (P1)	0 l/s
Extract GF2 (P2)	0 Pa
Extract GF2 (P2)	0 l/s
<span style="border: 1px solid #ccc; border-radius: 50%; padding: 2px 5px; display: inline-block;">↻</span> Zero-point calibration	

- None
- Analog 10V
- Modbus
- Individual
- Combined

**Info**

Real-time information and status from Pressure sensor.

The Pressure values GF1 and GF2 are direct values from the Pressure sensor, while the flow is the calculated flow dependent on the measured Pressure from the sensor and the K-factor of the fan.

**Zero-point calibration**

When the sensor type is selected to Modbus, you can do Zero-point calibration of the Pressure sensor via display. Alle connected hoses must be disconnected when performing calibration.

Service 1991 – Installation / Peripherals / Pressure/Flow / Flow – Modbus

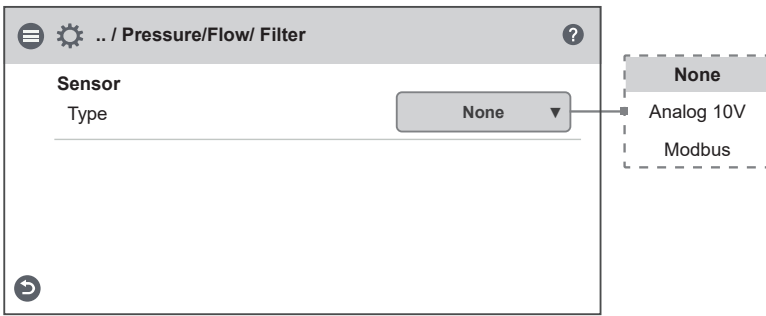

Service 1991 – Installation / Peripherals / Pressure/Flow / Filter

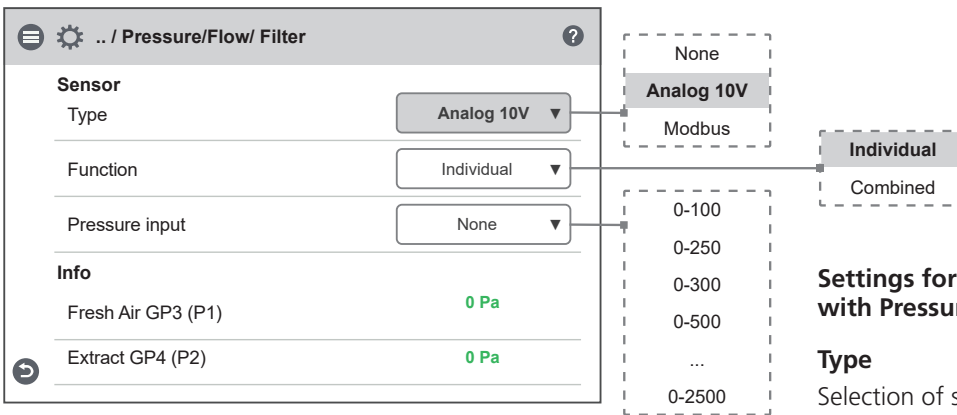

Service 1991 – Installation / Peripherals / Pressure/Flow / Filter – Analog 10V

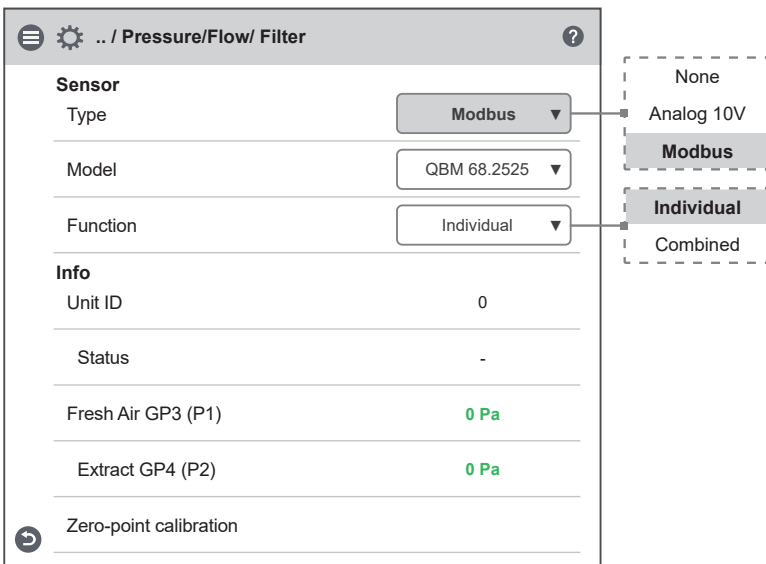

Service 1991 – Installation / Peripherals / Pressure/Flow / Filter – Modbus

### Settings for filter measurement with Pressure sensor

#### Type

Selection of signal type from sensor. Can be set to 0-10V or Modbus depending on peripherals.

If the sensor type is set to 0-10V, the Pressure range must be selected according to what is set in the Pressure sensor.

If the sensor type is set to Modbus, the Pressure range is set automatically.

#### Modell

Choice of supported Modell.

#### Function

Selection of the Pressure sensor operating function. Individual is used when the Pressure sensor is externally mounted outside the unit. Combined is used when it is internally mounted in the unit.

#### Info

Real-time information and status from the Pressure sensor.

The Pressure values GP3 and GP4 are direct actual values from the Pressure sensor.

#### Zero-point calibration

When the sensor type is selected to Modbus, you can do Zero-point calibration of the Pressure sensor via display. Alle connected hoses must be disconnected when performing calibration.

## 2.9.2 Installation – Fan regulation

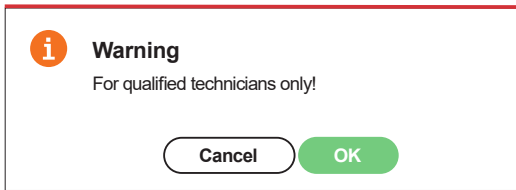

Service 1991 – Installation / Fan regulation – Pop-up

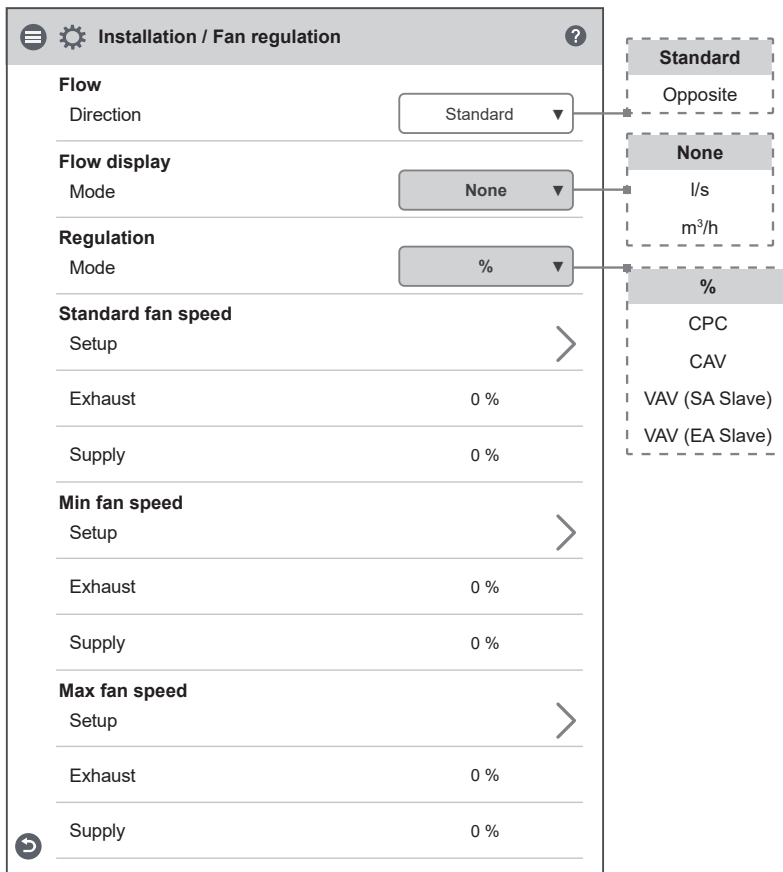

Service 1991 – Installation / Fan regulation “%”

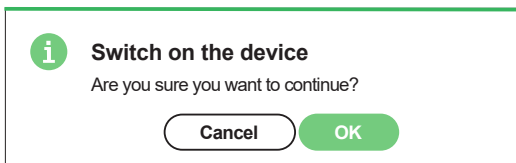

Service 1991 – Installation / Fan regulation – Pop-up

### “7.6 Fan regulation” page 44

#### Flow direction

Can be set to Standard or Motsatt. The “Motsatt” setting is only used on units that have a design that allows the flow direction to be changed. See manual of actual unit for more details.

#### Flow display

Selection of flow unit when presenting flow on Home screen advanced. If set to None, the unit for the selected control type (% , Pa) is displayed instead.

#### Regulation mode

Selection of fan control mode.

- Percent – %:  
Setting of fixed output signal to fans.
- CPC:  
Used to keep constant Pressure in duct. Regulates fan output signal to compensate for clogged filters. Setting of Pressure setpoints is done under setting page “CPC setup” for standard fan speed.

It is important that new filters are installed before saving reference setpoints!

- CAV:  
Used for flow regulation of the fans.
- VAV (SA Slave):  
The supply air fan is slave-controlled against the exhaust fan, where the supply air fan flow is regulated in relation to the exhaust fan flow + offset.
- VAV (EA Slave):  
The exhaust air fan is slave-controlled against the supply fan, where the exhaust air fan flow is regulated in relation to the supply fan flow + offset.

Text continuous on next page



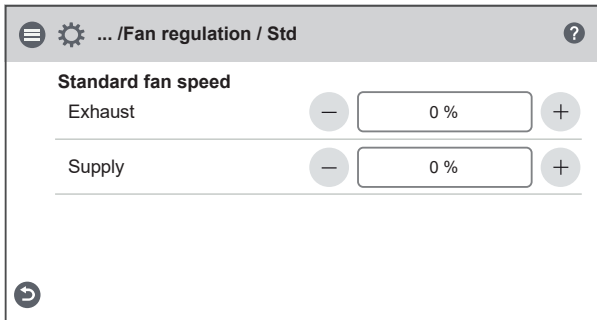

Service 1991 – Installation / Fan regulation “%” / Std fan speed

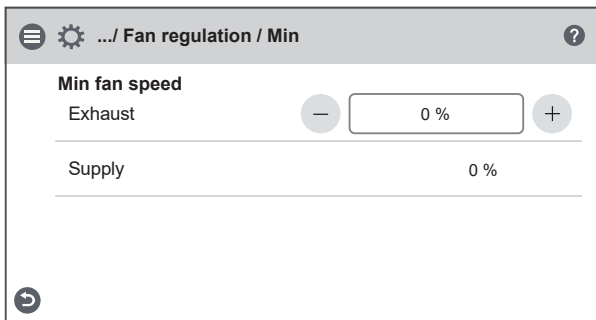

Service 1991 – Installation / Fan regulation “%” / Min fan speed

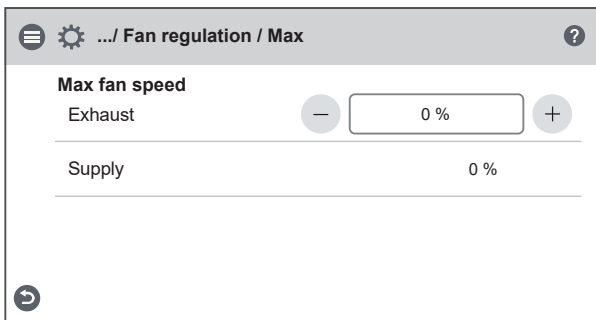

Service 1991 – Installation / Fan regulation “%” / Max fan speed

### Setpoint mode

In the case of control mode VAV, the setpoint mode used when adjusting flows can be selected.

- %:  
Output signal for fan is set in % and is then saved as a reference Pressure setpoint.
- Pa:  
The Pressure setpoint is set directly to the desired value.

### Offset mode

With control type VAV, offset type can be selected.

- Static: Offset for slave-controlled fan can be set individually for all three fan speeds.
- Relative: Offset for slave-controlled fan is automatically calculated for Min and Max speed based on ratio in Standard fan speed.

### Standard fan speed

When entering the setup page, all program parameters that affect the flow of the fans are temporarily deactivated and the program is entering adjustment mode.

When leaving the setup page, the unit returns to normal operation.

The standard fan speed is the position where adjustment of the ventilation system shall be made. The supply and exhaust air flow can be adjusted individually.

### Min and Max Speed

When entering the setup page, all program parameters that affect the flow of the fans are temporarily deactivated and the program is entering adjustment mode. When leaving the setup page, the unit returns to normal operation.

The exhaust air flow can be adjusted. The supply air flow is calculated automatically based on the ratio in Standard fan speed. In the case of VAV regulation with static offset, the supply and exhaust air flow can be set individually.

☰ ⚙️ **Installation / Fan regulation** ?

PID-Regulation >

---

**Flow**

Direction Standard ▼

---

**Flow display**

Mode None ▼

---

**Regulation**

Mode CPC ▼

---

**Standard fan speed**

CPC setup >

---

Exhaust 0 %

---

Extract Pressure setpoint 0 Pa

---

Extract Pressure 0 Pa

---

Supply 0 %

---

Supply Pressure setpoint 0 Pa

---

Supply Pressure 0 Pa

---

**Min fan speed**

Setup >

---

Exhaust 0 %

---

Supply 0 %

---

**Max fan speed**

Setup >

---

Exhaust 0 %

---

Supply 0 %

**Standard**

Opposite

**None**

l/s

m<sup>3</sup>/h

%

**CPC**

CAV

VAV (SA Slave)

VAV (EA Slave)

➡

Service 1991 – Installation / Fan regulation "CPC"

Service 1991 – Installation / Fan regulation "CPC" / PID-Regulation

### PID parameters

PID settings for Supply- and Exhaust fan.

#### NOTE!

Incorrectly adjusted regulator can create powerful imbalances and/or hysterical self-oscillation in the control function.

Service 1991 – Installation / Fan regulation "CPC" / CPC Settings

Service 1991 – Installation / Fan regulation "CPC" / Save Pop-up

Service 1991 – Installation / Fan regulation "CPC" / Min fan speed

Service 1991 – Installation / Fan regulation "CPC" / Max fan speed

The screenshot shows the 'Installation / Fan regulation' menu with the following sections and options:

- PID-Regulation**: >
- Flow**
  - Direction: Standard (dropdown)
- Flow display**
  - Mode: None (dropdown)
- Regulation**
  - Mode: CAV (dropdown)
- Standard fan speed**
  - CAV setup: >
  - Exhaust: 0 l/s
  - Supply: 0 l/s
- Min fan speed**
  - Setup: >
  - Exhaust: 0 l/s
  - Supply: 0 l/s
- Max fan speed**
  - Setup: >
  - Exhaust: 0 l/s
  - Supply: 0 l/s

Callouts on the right side of the menu:

- Standard** (dashed box): Opposite
- None** (dashed box): l/s, m³/h
- CAV** (dashed box): %, CPC, VAV (SA Slave), VAV (EA Slave)

Service 1991 – Installation / Fan regulation "CAV"

☰ ⚙️ ... / Fan regulation / PID-Regulation ?

<b>Exhaust</b>	
P	<input type="text" value="0.00"/>
I	<input type="text" value="0.00"/>
D	<input type="text" value="0.00"/>
<b>Supply</b>	
P	<input type="text" value="0.00"/>
I	<input type="text" value="0.00"/>
D	<input type="text" value="0.00"/>

➡

Service 1991 – Installation / Fan regulation "CAV" / PID-Regulation

☰ ⚙️ Installation / Standard Setup ?

<b>Standard fan speed</b>	
Exhaust	– <input type="text" value="0 l/s"/> +
Exhaust flow	0 l/s
Supply	– <input type="text" value="0 l/s"/> +
Supply flow	0 l/s

➡

Service 1991 – Installation / Fan regulation "CAV" / Standard Setup

☰ ⚙️ ... / Fan regulation / Min ?

<b>Min fan speed</b>	
Exhaust	– <input type="text" value="0 l/s"/> +
Exhaust flow	0 l/s
Supply	– <input type="text" value="0 l/s"/> +
Supply flow	0 l/s

➡

Service 1991 – Installation / Fan regulation "CAV" / Min fan speed

☰ ⚙️ ... / Fan regulation / Max ?

<b>Max fan speed</b>	
Exhaust	– <input type="text" value="0 l/s"/> +
Exhaust flow	0 l/s
Supply	– <input type="text" value="0 l/s"/> +
Supply flow	0 l/s

➡

Service 1991 – Installation / Fan regulation "CAV" / Max fan speed

**Installation / Fan regulation**

PID-Regulation >

**Flow**

Direction: Standard

**Flow display**

Mode: None

**Regulation**

Mode: VAV (SA Slave)

**Setpoint**

Mode: %

**Offset**

Mode: Static

**Standard fan speed**

VAV setup >

Exhaust	0 %
Extract Pressure setpoint	0 Pa
Supply offset	0 l/s

**Min fan speed**

Setup >

Exhaust	0 %
Extract Pressure setpoint	0 Pa
Supply offset	0 l/s

**Max fan speed**

Setup >

Exhaust	0 %
Extract Pressure setpoint	0 Pa
Supply offset	0 l/s

Callouts:

- Standard**: Opposite
- None**: l/s, m³/h
- %**: CPC, CAV, VAV (SA Slave), VAV (EA Slave)
- Pa**: Pa
- Static**: Relative

Service 1991 – Installation / Fan regulation "VAV (SA Slave)"

**.. / Fan regulation / PID-Regulation**

**Exhaust**

P: 0.00

I: 0.00

D: 0.00

**Supply**

P: 0.00

I: 0.00

D: 0.00

Service 1991 – Installation / Fan regulation "VAV (SA Slave)" / PID-Regulation

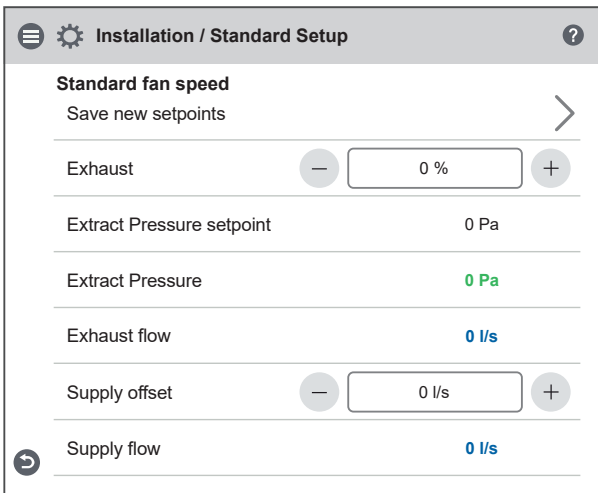

Service 1991 – Installation / Fan regulation "VAV (SA Slave)" / Std fan speed

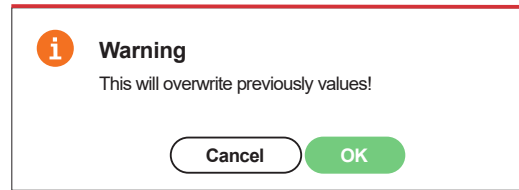

Service 1991 – Installation / Fan regulation "VAV (SA Slave)" / Save Pop-up

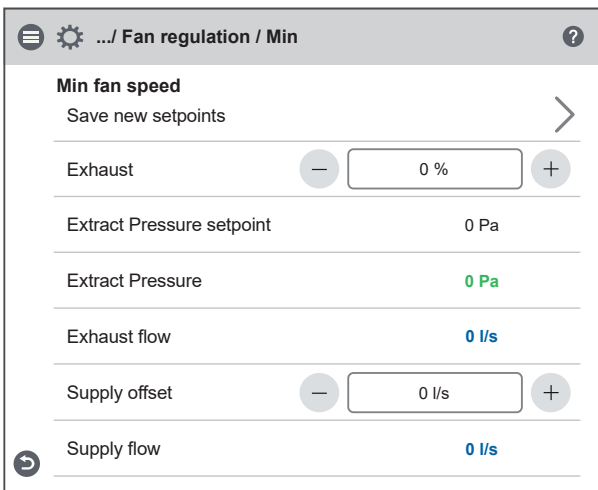

Service 1991 – Installation / Fan regulation "VAV (SA Slave)" / Min fan speed

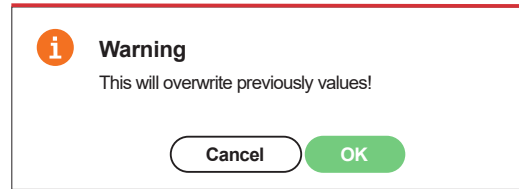

Service 1991 – Installation / Fan regulation "VAV (SA Slave)" / Save Pop-up

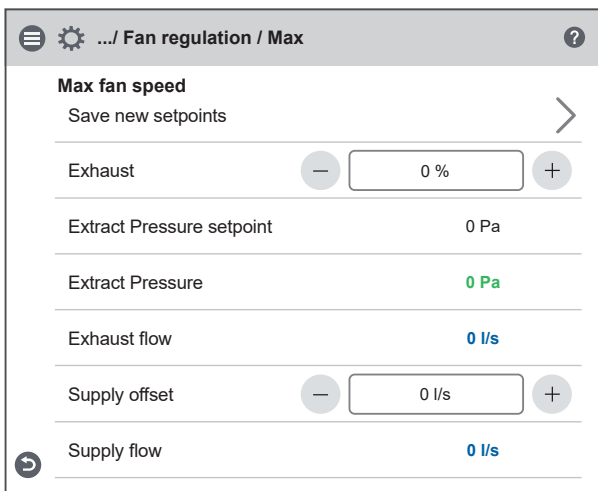

Service 1991 – Installation / Fan regulation "VAV (SA Slave)" /Max fan speed

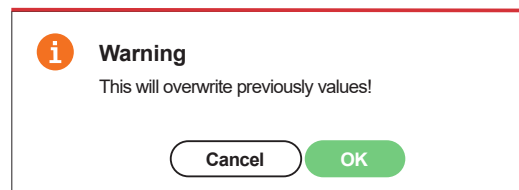

Service 1991 – Installation / Fan regulation "VAV (SA Slave)" / Save Pop-up

**Installation / Fan regulation**

PID-Regulation >

**Flow**

Direction: Standard

**Flow display**

Mode: None

**Regulation**

Mode: VAV (EA Slave)

**Setpoint**

Mode: %

**Offset**

Mode: Static

**Standard fan speed**

VAV setup >

Supply	0 %
Supply Pressure setpoint	0 Pa
Exhaust offset	0 l/s

**Min fan speed**

Setup >

Supply	0 %
Supply Pressure setpoint	0 Pa
Exhaust offset	0 l/s

**Max fan speed**

Setup >

Supply	0 %
Supply Pressure setpoint	0 Pa
Exhaust offset	0 l/s

Callouts:

- Standard: Opposite
- None: l/s, m³/h
- %: CPC, CAV, VAV (SA Slave), VAV (EA Slave)
- Pa: VAV (EA Slave)
- Static: Relative

Service 1991 – Installation / Fan regulation "VAV (EA Slave)"

**.. / Fan regulation / PID-Regulation**

**Exhaust**

P: 0.00

I: 0.00

D: 0.00

**Supply**

P: 0.00

I: 0.00

D: 0.00

Service 1991 – Installation / Fan regulation "VAV (EA Slave)" / PID-Regulation

**Installation / Standard Setup**

**Standard fan speed**  
Save new setpoints

Supply: 0 %

Supply Pressure setpoint: 0 Pa

Supply Pressure: 0 Pa

Supply flow: 0 l/s

Exhaust offset: 0 l/s

Exhaust flow: 0 l/s

Exhaust start-up: 0 l/s

Service 1991 – Installation / Fan regulation "VAV (EA Slave)" / Std fan speed

**Warning**  
This will overwrite previously values!

Cancel OK

Service 1991 – Installation / Fan regulation "VAV (SA Slave)" / Save Pop-up

**.../ Fan regulation / Min**

**Min fan speed**  
Save new setpoints

Supply: 0 %

Supply Pressure setpoint: 0 Pa

Supply Pressure: 0 Pa

Supply flow: 0 l/s

Exhaust offset: 0 l/s

Exhaust flow: 0 l/s

Service 1991 – Installation / Fan regulation "VAV (EA Slave)" / Min fan speed

**Warning**  
This will overwrite previously values!

Cancel OK

Service 1991 – Installation / Fan regulation "VAV (SA Slave)" / Save Pop-up

**.../ Fan regulation / Max**

**Max fan speed**  
Save new setpoints

Supply: 0 %

Supply Pressure setpoint: 0 Pa

Supply Pressure: 0 Pa

Supply flow: 0 l/s

Exhaust offset: 0 l/s

Exhaust flow: 0 l/s

Service 1991 – Installation / Fan regulation "VAV (EA Slave)" / Max fan speed

**Warning**  
This will overwrite previously values!

Cancel OK

Service 1991 – Installation / Fan regulation "VAV (SA Slave)" / Save Pop-up

### 2.9.3 Installation – Temperature regulation

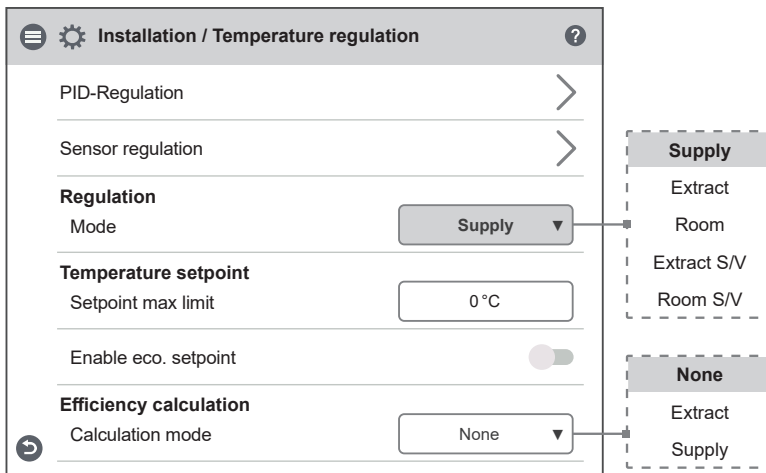

Service 1991 – Installation / Temperature regulation

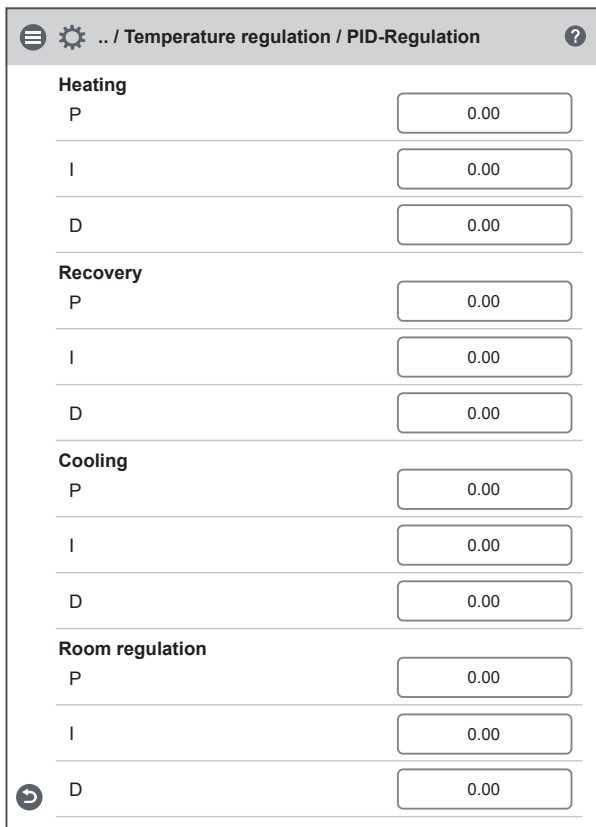

Service 1991 – Installation / Temperature regulation / PID-regulation

#### “7.2 Temperature Regulation” page 34

##### PID parameters

PID settings for Heating, Recovery, Cooling and Room regulation.

##### NOTE!

Change only if necessary. Incorrectly adjusted regulator can create powerful imbalances and/or hysterical self-oscillation in the control function.

##### Sensor Adjustment

Each sensor can be adjusted individually with  $\pm 5$  K if needed.

##### Regulation Type

- Supply compare the temperature setpoint against the temperature in the supply air.
- Extract air compare the setpoint against the temperature in the extract air and regulates the temperature in the supply air between the set Min/Max limits.
- Room compare the setpoint against the temperature from the room sensor and regulates the temperature in the supply air between the set Min/Max limits.
- Extract S/V and Room S/V enable automatic changeover of control type to supply air regulation in wintertime.

Changeover can be made on temperature criterion, date or via external input.

When extract S/V or Room S/V is selected, a temperature offset factor can be set. This factor only affects supply air regulation in winter.

##### Setpoint max limit

Sets a maximum limit on the temperature setpoint setting. Extra economy temperature setpoint can be activated, which allows for two temperature setpoints in the scheduler.

##### Efficiency Calculation

Setting for which type of efficiency calculation to apply.

☰ ⚙️ .. / Temperature regulation / Sensor adjustment
?

T1 (Outdoor)	0.0 K
T2 (Rotor)	0.0 K
T3 (Extract)	0.0 K
T4 (Exhaust)	0.0 K
T5 (Water)	0.0 K
T6 (Supply)	0.0 K
T7 (Room)	0.0 K

Service 1991 – Installation / Temperature regulation / Sensor adjustment

☰ ⚙️ Installation / Temperature regulation
?

PID-Regulation >

Sensor regulation >

**Regulation**

Mode Supply ▼

**Temperature setpoint**

Setpoint max limit 0 °C

Enable eco. setpoint

**Efficiency calculation**

Calculation mode None ▼

Supply

Extract

Room

Extract S/V

Room S/V

None

Extract

Supply

Service 1991 – Installation / Temperature regulation / Supply

☰ ⚙️ Installation / Temperature regulation
?

PID-Regulation >

Sensor regulation >

**Regulation**

Mode Extract ▼

Supply limit min 0 °C

Supply limit max 0 °C

**Temperature setpoint**

Setpoint max limit 0 °C

Enable eco. setpoint

**Efficiency calculation**

Calculation mode None ▼

Supply

Extract

Room

Extract S/V

Room S/V

None

Extract

Supply

Service 1991 – Installation / Temperature regulation / Extract

**Installation / Temperature regulation**

PID-Regulation >

Sensor regulation >

**Regulation**

Mode **Room** ▼

Supply limit min 0 °C

Supply limit max 0 °C

**Temperature setpoint**

Setpoint max limit 0 °C

Enable eco. setpoint

**Efficiency calculation**

Calculation mode **None** ▼

Dynamic menu for **Room**: Supply, Extract, **Room**, Extract S/V, Room S/V

Dynamic menu for **None**: **None**, Extract, Supply

Service 1991 – Installation / Temperature regulation / Room

**Installation / Temperature regulation**

PID-Regulation >

Sensor regulation >

**Regulation**

Mode **Extract S/V** ▼

Supply limit min 0 °C

Supply limit max 0 °C

**Changeover**

**Temp.** ▼

Winter start 0 °C

Summer start 0 °C

Time constant 0 h

Supply temp. offset 0 K

**Temperature setpoint**

Setpoint max limit 0 °C

Enable eco. setpoint

**Efficiency calculation**

Calculation mode **None** ▼

Dynamic menu for **Extract S/V**: Supply, Extract, Room, **Extract S/V\***, **Room S/V\***

Dynamic menu for **Temp.**: **Temp.**, Date, External input

Dynamic menu for **None**: **None**, Extract, Supply

Service 1991 – Installation / Temp regulation / Extract & Room S/V – Temp

\* The dynamic menus are same for both Extract S/V and Room S/V.

**Installation / Temperature regulation**

PID-Regulation >

Sensor regulation >

**Regulation**

Mode: **Extract S/V** ▼

Supply limit min: 0 °C

Supply limit max: 0 °C

Changeover: **Date** ▼

Winter start: 01-01 (MM-DD)

Summer start: 01-01 (MM-DD)

Supply temp. offset: 0 K

**Temperature setpoint**

Setpoint max limit: 0 °C

Enable eco. setpoint:

**Efficiency calculation**

Calculation mode: None ▼

**Dynamic menu options:**

- Supply
- Extract
- Room
- Extract S/V\***
- Room S/V\***
- Temp.
- Date**
- External input
- None**
- Extract
- Supply

\* The dynamic menus are same for both Extract S/V and Room S/V.

Service 1991 – Installation / Temp regulation / Extract & Room S/V – Date

**Installation / Temperature regulation**

PID-Regulation >

Sensor regulation >

**Regulation**

Mode: **Extract S/V** ▼

Supply limit min: 0 °C

Supply limit max: 0 °C

Changeover: **External input** ▼

Supply temp. offset: 0 K

**Temperature setpoint**

Setpoint max limit: 0 °C

Enable eco. setpoint:

**Efficiency calculation**

Calculation mode: None ▼

**Dynamic menu options:**

- Supply
- Extract
- Room
- Extract S/V\***
- Room S/V\***
- Temp.
- Date
- External input**
- None**
- Extract
- Supply

\* The dynamic menus are same for both Extract S/V and Room S/V.

Service 1991 – Installation / Temp regulation / Extract & Room S/V – Ext. input

### 2.9.4 Installation – Filter monitoring

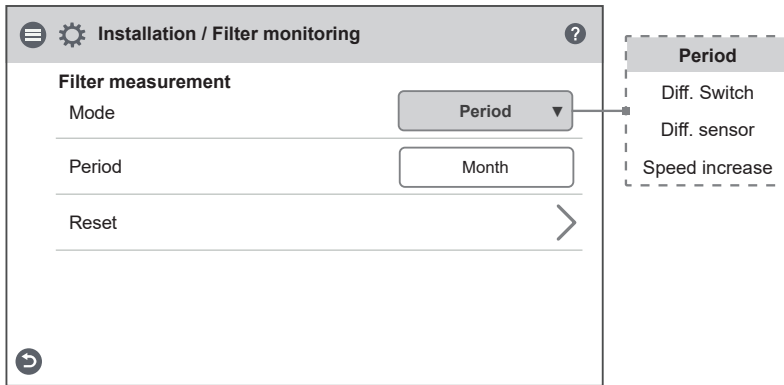

Service 1991 – Installation / Filter monitoring – Period

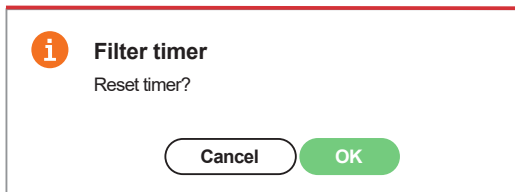

Service 1991 – Installation / Filter monitoring – Pop-up

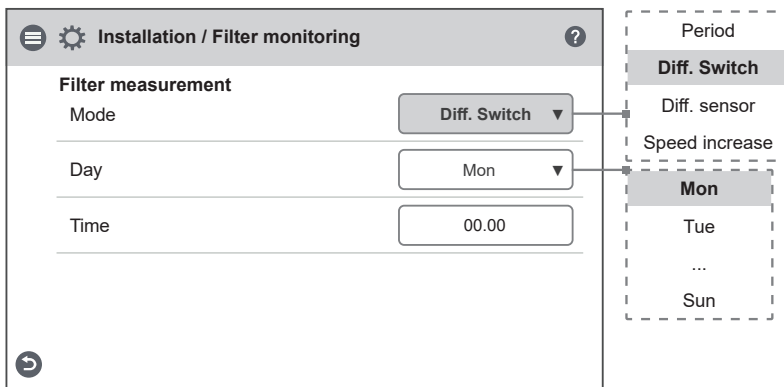

Service 1991 – Installation / Filter monitoring – Diff switch

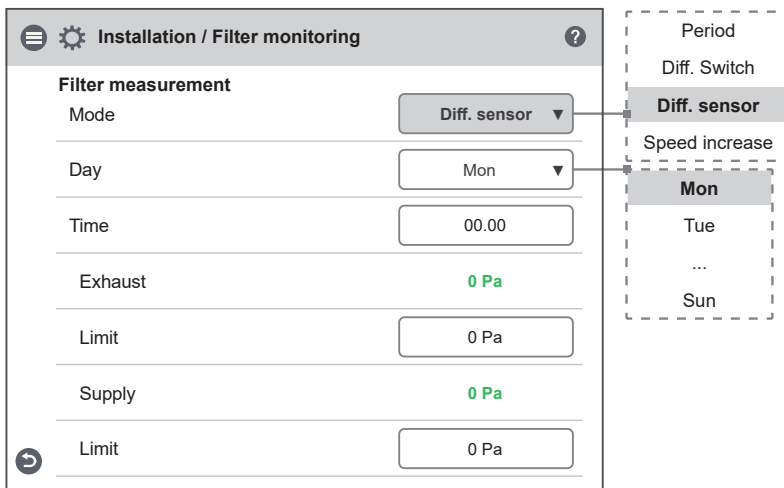

Service 1991 – Installation / Filter monitoring – Diff sensor

#### “7.12 Filter monitoring” page 49

#### Filter Measurement

Type of filter control.

- **Period:**  
Selected by default. Gives an alarm when the service period has expired. Reset starts new service period.
- **Diff. switch:**  
Scheduled filter measurement at selected day and time (requires accessories). The choice “ Diff. switch ” is hidden if Emergency stop / Service Switch is set to other than “None”.
- **Diff. sensor:**  
Scheduled filter measurement at selected day and time. Compare measured value against set final Pressure drop (requires accessories).
- **Speed increase:**  
In CPC control of fans, the output signal of the fans can be used as a reference when measuring filter clogging. The limit value for filter alarms is the saved reference value of the fans increased by the set value for speed increase. Speed increase means keeping a constant Pressure in the duct by increasing the fans’ output signal to compensate for clogged filters (requires accessories).

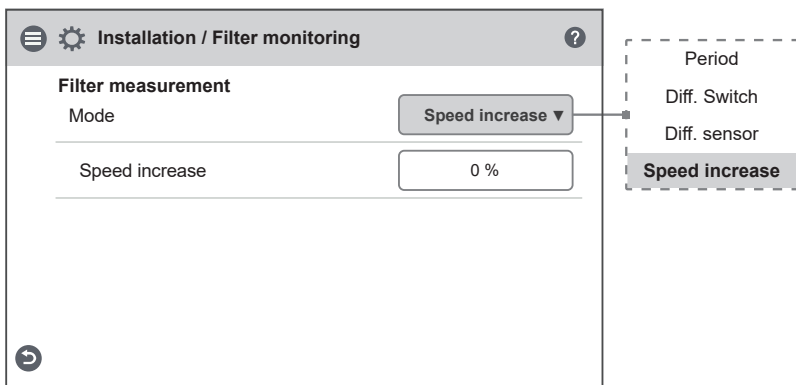

Service 1991 – Installation / Filter monitoring – Speed increase

## 2.9.5 Installation – Alarm parameters

The screenshot shows the 'Installation / Alarm parameters' menu. The 'Fire mode' dropdown is set to 'Fans off'. To the right, a dashed box indicates the available options: 'Not installed', 'NO\*', 'NC\*', 'Fans off', 'Supply fan only', 'Exhaust fan only', and 'Both fans'. The 'Fans off' option is highlighted.

Service 1991 – Installation / Alarm parameters – Fans off

The screenshot shows the 'Installation / Alarm parameters' menu. The 'Fire mode' dropdown is set to 'Supply fan only'. To the right, a dashed box indicates the available options: 'Not installed', 'NO', 'NC', 'Fans off', 'Supply fan only', 'Exhaust fan only', and 'Both fans'. The 'Supply fan only' option is highlighted.

Service 1991 – Installation / Alarm parameters – Supply fans only

### “7.5 Alarms and limits” page 41

#### Supply air temperature Low

- Limit A: Temperature limit when alarms for low supply air temperature will be given.
- Limit B: At which temperature limit the fan reduction will be activated.
- Fan reduction: Reduction of supply air fan. min 10%, max%. diff between Max and Min speed.

#### Freeze protection

- Hold temperature: When the plant is switched off, the water coil is kept warm so that the return water temperature is the same as the holding temperature setpoint.
- Limit B: Temperature limit value where heat valve is forced to full open.
- Limit A: Temperature limit where also the unit is stopped if it is in operation.

#### Preheater

Temperature setpoint is set to when preheater is to start support heat the cold fresh air.

The pre-heater is controlled against the temperature at the outdoor air filter and is activated when the temperature in the outdoor air falls below the set setpoint.

#### Fire Parameters

- Sensor type: Selection of contact function from external fire equipment.
- Fire mode: Function of fans in case of fire alarm.
- Forced speed: If fan is forced into operation, the % output signal will be used.

\* The dynamic menus are same for both NO and NC.



☰ **Installation / Alarm parameters** ?

**Supply cold**

Limit B

---

Limit A

---

Fan reduction

---

**Freeze protection water**

Holding temp

---

Limit B

---

Limit A

---

**Preheater**

Temperature setpoint

---

**Fire parameters**

Sensor type

---

Fire mode

---

Forced exhaust fan speed

---

Automatický reset

---

**Menu continuous in another frame >>>>**

Not installed

**NO**

**NC**

Fans off

Supply fan only

**Exhaust fan only**

Both fans

Service 1991 – Installation / Alarm parameters – Exhaust fan only

☰ **Installation / Alarm parameters** ?

**Supply cold**

Limit B

---

Limit A

---

Fan reduction

---

**Freeze protection water**

Holding temp

---

Limit B

---

Limit A

---

**Preheater**

Temperature setpoint

---

**Fire parameters**

Sensor type

---

Fire mode

---

Forced Supply fan speed

---

Forced exhaust fan speed

---

Automatický reset

---

**Menu continuous in another frame >>>>**

Not installed

**NO**

**NC**

Fans off

Supply fan only

Exhaust fan only

**Both fans**

Service 1991 – Installation / Alarm parameters – Both fans

Service 1991 – Installation / Alarm parameters – Both fans and afterheater PAC-IF013 (section)

### Gassdetektor

Function is available when a certain type of afterheater or cooling is selected, in this case PAC-IF013. The alarm function is activated via external input.

- In normal operation: If the output signal from the exhaust air motor is lower than the set value, the exhaust air motor is overridden with the set value. If the output signal from the exhaust air motor is higher, the current output signal is used.
- In Energy saving mode: Damper opening time is awaited before starting the exhaust air motor. The exhaust air motor is then controlled on a fixed output signal according to the set value.

### NOTE!

**Defrost parameter** (1) and **Gassdetektor** (2) replaces **Freeze protection water** and **Preheater** (see previous menus) in the menu, independent of other choices made in the menu.

>>>> from previous frame

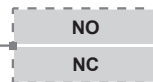

### With expansion

#### Alarm outputs

- A-relay state: Contact function during normal operation.
- B-relay state: Contact function during normal operation.
- Run-relay state: Contact function during normal operation.

#### Alarm relay alerts

Which alarms that will affect alarm output. Depending on the alarm class, the A-relay or the B-relay is affected.

\* The dynamic menus are same for both NO and NC.

Service 1991 – Installation / Alarm parameters – Alarm parameters

## 2.9.6 Installation – Alarm class

Settings of which alarm class that resp. alarm should have.

### Two levels can be selected

- A-alarm: A critical alarm that will stop the unit.
- B-alarm: A non-critical alarm that keeps the unit in operation.

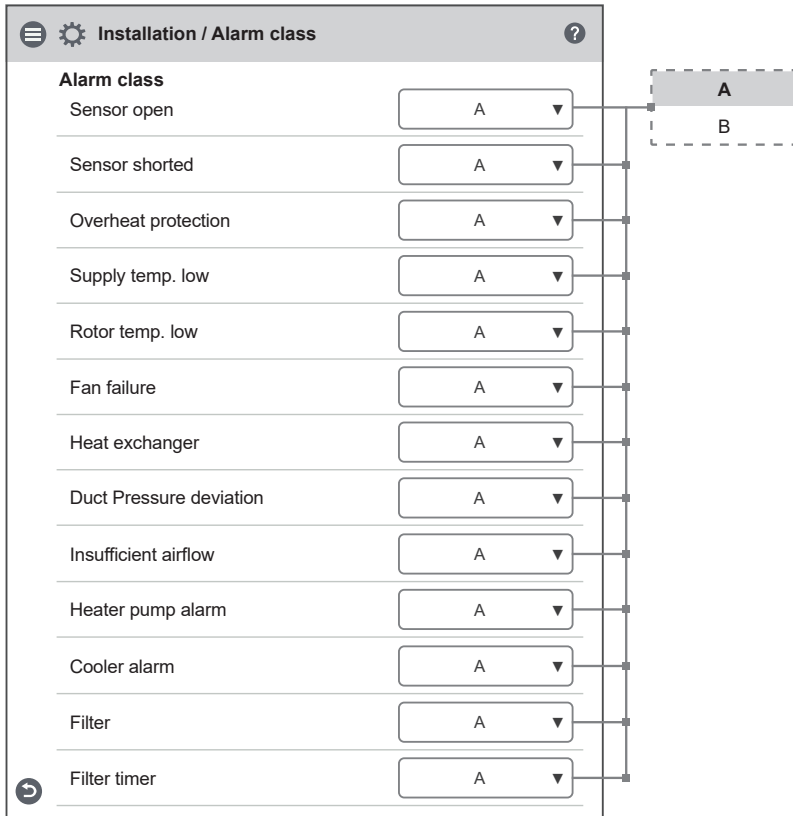

Service 1991 – Installation / Alarm class

### 2.9.7 Installation – RH/CO2/VOC Boost

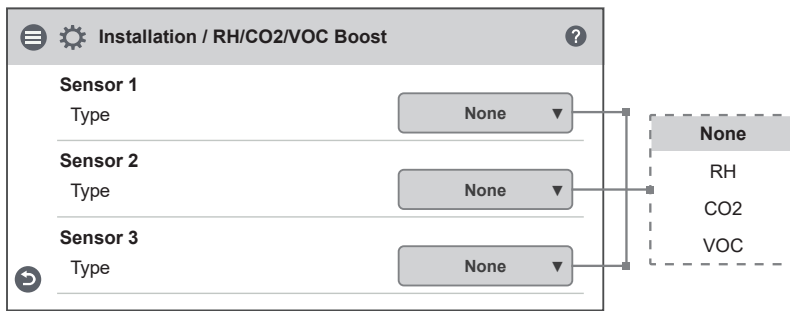

Service 1991 – Installation / RH/CO2/VOC Boost

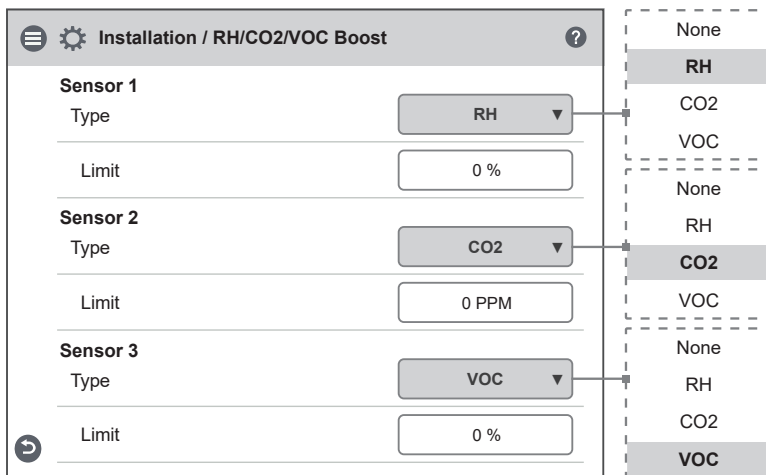

Service 1991 – Installation / RH/CO2/VOC Boost

#### “6.7 RH / CO2 / VOC sensor inputs” page 32

Demand control via active sensor. If the limit value is exceeded, the supply and exhaust air flow will be increased to the set maximum flow.

When more than one transducer is used, the greatest value is prioritized.

#### Sensor 1

Controller supports connection of 1 sensor.

#### Sensor 2 & 3

An additional 2 sensors can be connected via accessories. Needs a expansion board.

### 2.9.8 Installation – Communications

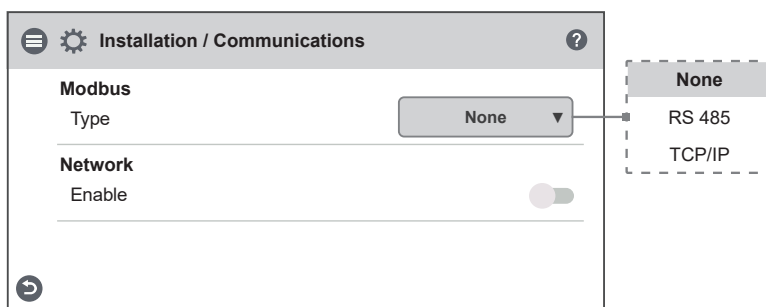

Service 1991 – Installation / Communications

#### Modbus settings

##### Type RS 485

- Address: Modbus ID on the device.
- Baud: The communication speed used on the serial network.
- Stop bit: Selection of number of stop bits used.
- Parity: Selection of parity check type, if used.

##### Type TCP/IP

- Port: Port to receive and send Modbus data.

#### Network

DHCP: Enable to be automatically assigned an IP address and DNS server dynamically from the network.

If a static IP address is to be used, data for IP, Netmask, Gateway and DNS is entered manually.

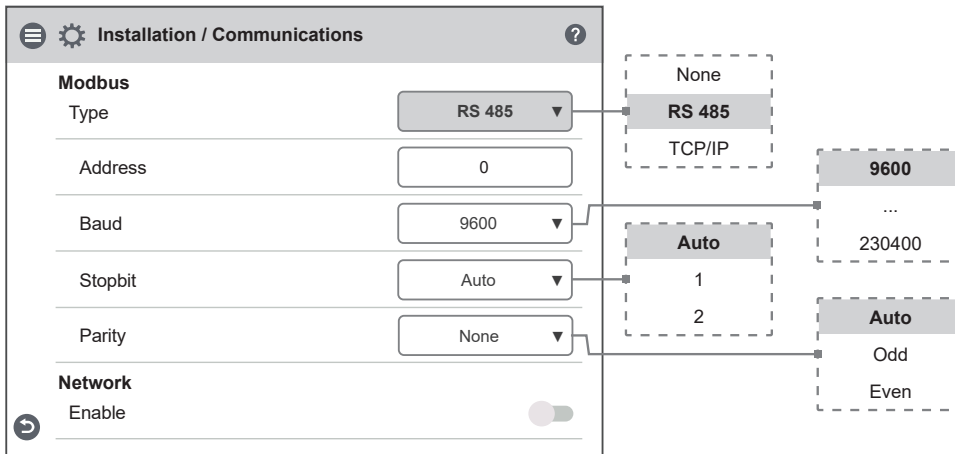

Service 1991 – Installation / Communications – RS 485

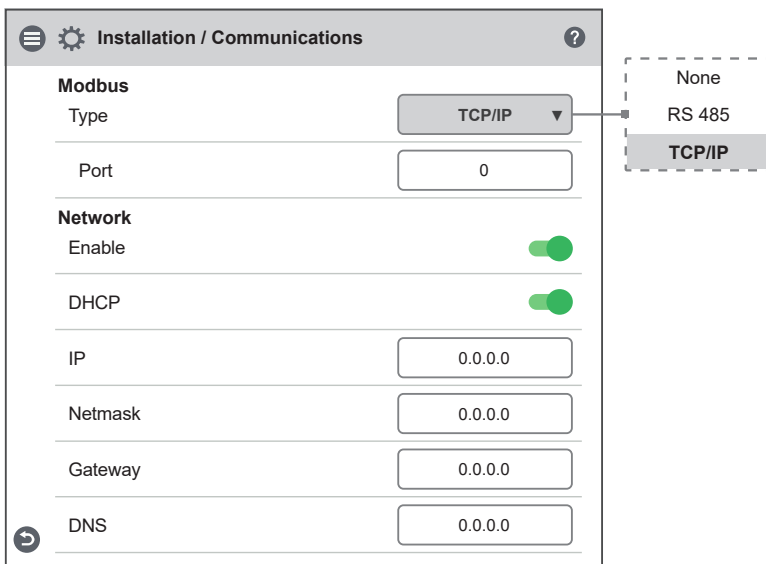

Service 1991 – Installation / Communications – TCP/IP

### 2.9.9 Installation – Alarm history

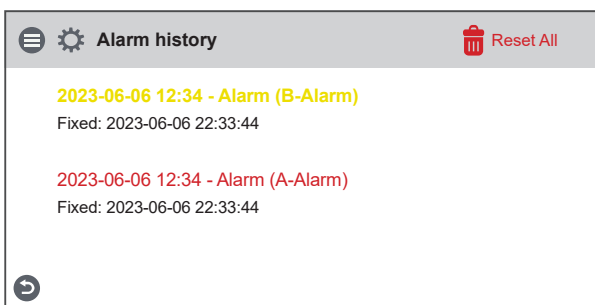

Service 1991 – Installation / Alarm history

#### Alarm history

List of old alarms in the unit.

The date and time indicate when the alarms occurred and when it was reset.

For a more detailed description of the alarm, tap on specific alarm row.

Red text represents A-alarm.

Yellow text B-alarm.

### 2.9.10 Installation – Operation info

Installation / Operation info	
<b>Temp. Sensors</b>	
T1 (Outdoor)	0.0 °C
T2 (Rotor)	0.0 °C
T3 (Extract)	0.0 °C
T4 (Exhaust)	0.0 °C
T5 (Water)	0.0 °C
T6 (Supply)	0.0 °C
T7 (Room)	0.0 °C
<b>Input signal levels</b>	
S1	0.0 V
S2	0.0 V
S3	0.0 V
Setpoint adjustment Comfort temp.	0.0 V
X11a	0.0 V
X11b	0.0 V
X12a	0.0 V
X12b	0.0 V
X13a	0.0 V
X13b	0.0 V
<b>Output signal levels</b>	
Fan 1	0.0 V
Fan 2	0.0 V
Water heater	0.0 V
Cooling	0.0 V
<b>Menu continuous in another frame &gt;&gt;&gt;&gt;&gt;</b>	

Service 1991 – Installation / Operation info – Part 1. S2 and S3 is only visible with a expansion board installed and activated.

Demands a expansion board installed and activated.

- Setpoint adjustment comfort temp.
- X11a-X13b

Is only visible when expansion board or mini expansion is installed and activated.

- Cooling

Installation / Operation info	
<b>PWM Outputs</b>	
Preheater	0 %
X3:5 (Recovery)	0 %
Afterheater	0 %
<b>Switch input status</b>	
Fire alarm	0
Heater pump alarm	0
Boost	0
Overpressure	0
Extended operation	0
Away	0
Preheater overheated	0
Afterheater overheated	0
Electric heater locked	0
Rotor sensor	0
Summer- / Winter changeover	0
Cooler alarm	0
Gas detector	0
<b>Digital outputs</b>	
Cooling	0
A-relay state	0
B-relay state	0
Run-relay state	0

Service 1991 – Installation / Operation info – Part 2.

Demands a expansion board installed and activated.

- Summer- /Winter change over.
- Gassdetektor
- A-relay state
- B-relay state
- Run-relay state

Is only visible when expansion board or mini expansion is installed and activated.

- Cooler alarm
- Cooling

## 2.9.11 Installation – Load & Save

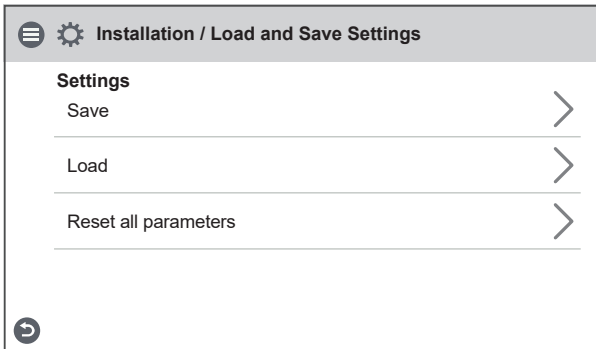

Service 1991 – Installation / Load and save settings

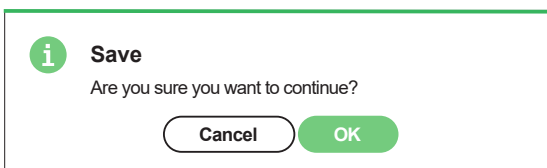

Service 1991 – Installation / save settings pop-up

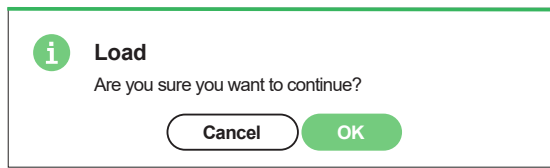

Service 1991 – Installation / Load settings pop-up

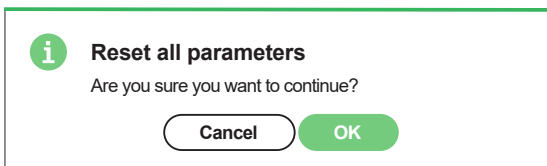

Service 1991 – Installation / Reset pop-up

## 2.10 Turn on/off unit

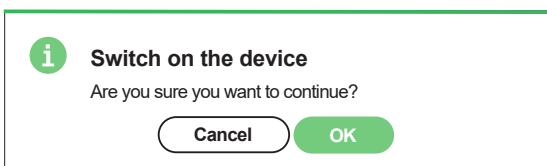

Turn on unit pop-up

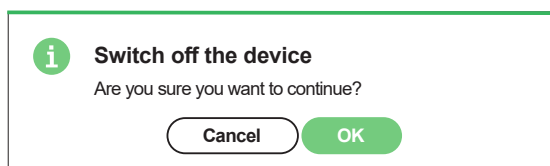

Turn off unit pop-up





energy  
efficient  
ventilation

**ÖSTBERG** 

**H ÖSTBERG AB**

Box 54, SE-774 22 Avesta, Sweden

Phone: +46 226 860 00

E-mail: [info@ostberg.com](mailto:info@ostberg.com)

[www.ostberg.com](http://www.ostberg.com)